

HP 83204A Cellular Adapter Assembly Level Repair

for use with
HP 8921A Cell Site Test Set

This manual applies directly to the following instruments:
HP 83204A TDMA Cellular Adapter (Option 001)
HP 83204A CDPD Cellular Adapter (Option 002)
HP 83204A TDMA/CDPD Cellular Adapter (Option 003)

Option 001

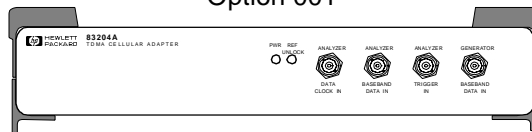

Option 002

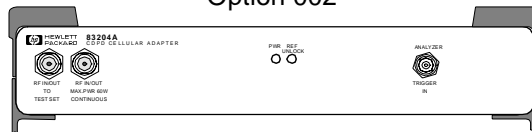

Option 003

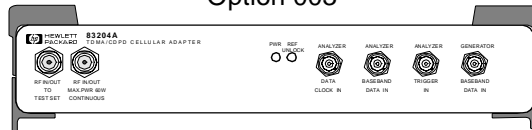

HP Part No. 83204-90018
Printed in U. S. A.
January 1997

Rev B

Copyright © Hewlett-Packard Company 1995

Notice

Information contained in this document is subject to change without notice.

All Rights Reserved. Reproduction, adaptation, or translation without prior written permission is prohibited, except as allowed under the copyright laws.

This material may be reproduced by or for the U.S. Government pursuant to the Copyright License under the clause at DFARS 52.227-7013 (APR 1988).

Hewlett-Packard Company
Learning Products Department
24001 E. Mission
Liberty Lake, WA 99019-9599
U.S.A.

Manufacturer's Declaration

This statement is provided to comply with the requirements of the German Sound Emission Directive, from 18 January 1991.

This product has a sound pressure emission (at the operator position) < 70 dB(A).

- Sound Pressure $L_p < 70$ dB(A).
- At Operator Position.
- Normal Operation.
- According to ISO 7779:1988/EN 27779:1991 (Type Test).

Herstellerbescheinigung

Diese Information steht im Zusammenhang mit den Anforderungen der Maschinenlärminformationsverordnung vom 18 Januar 1991.

- Schalldruckpegel $L_p < 70$ dB(A).
- Am Arbeitsplatz.
- Normaler Betrieb.
- Nach ISO 7779:1988/EN 27779:1991 (Typprüfung).

Safety Considerations

GENERAL

This product and related documentation must be reviewed for familiarization with safety markings and instructions before operation.

This product has been designed and tested in accordance with *IEC Publication 1010*, "Safety Requirements for Electronic Measuring Apparatus," and has been supplied in a safe condition. This instruction documentation contains information and warnings which must be followed by the user to ensure safe operation and to maintain the product in a safe condition.

SAFETY EARTH GROUND

A uninterruptible safety earth ground must be provided from the main power source to the product input wiring terminals, power cord, or supplied power cord set.

CHASSIS GROUND TERMINAL

To prevent a potential shock hazard, always connect the rear-panel chassis ground terminal to earth ground when operating this instrument from a dc power source.

SAFETY SYMBOLS



Indicates instrument damage can occur if indicated operating limits are exceeded. Refer to instruction in this guide.



Indicates hazardous voltages.



Indicates earth (ground) terminal

WARNING:

A WARNING note denotes a hazard. It calls attention to a procedure, practice, or the like, which, if not correctly performed or adhered to, could result in personal injury. Do not proceed beyond a WARNING sign until the indicated conditions are fully understood and met.

CAUTION:

A CAUTION note denotes a hazard. It calls attention to an operation procedure, practice, or the like, which, if not correctly performed or adhered to, could result in damage to or destruction of part or all of the product. Do not proceed beyond an CAUTION note until the indicated conditions are fully understood and met.

Safety Considerations for this Instrument

WARNING

This product is a Safety Class I instrument (provided with a protective earthing ground incorporated in the power cord). The mains plug shall only be inserted in a socket outlet provided with a protective earth contact. Any interruption of the protective conductor inside or outside of the product is likely to make the product dangerous. Intentional interruption is prohibited.

Whenever it is likely that the protection has been impaired, the instrument must be made inoperative and be secured against any unintended operation.

If this instrument is to be energized via an autotransformer (for voltage reduction), make sure the common terminal is connected to the earth terminal of the power source.

If this product is not used as specified, the protection provided by the equipment could be impaired. This product must be used in a normal condition (in which all means for protection are intact) only.

No operator serviceable parts are in this product. Refer servicing to qualified personnel. To prevent electrical shock, do not remove covers.

Servicing instructions are for use by qualified personnel only. To avoid electrical shock, do not perform any servicing unless you are qualified to do so.

The opening of covers or removal of parts is likely to expose dangerous voltages. Disconnect the product from all voltage sources while it is being opened.

Adjustments described in the manual are performed with power supplied to the instrument while protective covers are removed. Energy available at many points may, if contacted, result in personal injury.

The power cord is connected to internal capacitors that may remain live for 5 seconds after disconnecting the plug from its power supply.

For continued protection against fire hazard, replace the line fuse(s) only with 250 V fuse(s) or the same current rating and type (for example, normal blow or time delay). Do not use repaired fuses or short circuited fuseholders.

WARNING:

This product is a Safety Class I instrument (provided with a protective earthing ground incorporated in the power cord). The mains plug shall only be inserted in a socket outlet provided with a protective earth contact. Any interruption of the protective conductor inside or outside of the product is likely to make the product dangerous. Intentional interruption is prohibited.

Whenever it is likely that the protection has been impaired, the instrument must be made inoperative and be secured against any unintended operation.

If this instrument is to be energized via an autotransformer (for voltage reduction), make sure the common terminal is connected to the earth terminal of the power source.

If this product is not used as specified, the protection provided by the equipment could be impaired. This product must be used in a normal condition (in which all means for protection are intact) only.

No operator serviceable parts are in this product. Refer servicing to qualified personnel. To prevent electrical shock, do not remove covers.

Servicing instructions are for use by qualified personnel only. To avoid electrical shock, do not perform any servicing unless you are qualified to do so.

The opening of covers or removal of parts is likely to expose dangerous voltages. Disconnect the product from all voltage sources while it is being opened.

Adjustments described in the manual are performed with power supplied to the instrument while protective covers are removed. Energy available at many points may, if contacted, result in personal injury.

The power cord is connected to internal capacitors that may remain live for 5 seconds after disconnecting the plug from its power supply.

For continued protection against fire hazard, replace the line fuse(s) only with 250 V fuse(s) or the same current rating and type (for example, normal blow or time delay). Do not use repaired fuses or short circuited fuseholders.

CAUTION:

Always use the three-prong ac power cord supplied with this product. Failure to ensure adequate earth grounding by not using this cord may cause product damage.

This product is designed for use in Installation Category II and Pollution Degree 2 per *IEC 1010* and *IEC 664* respectively. For indoor use only.

This product has autoranging line voltage input, be sure the supply voltage is within the specified range.

Ventilation Requirements: When installing the product in a cabinet, the convection into and out of the product must not be restricted. The ambient temperature (outside the cabinet) must be less than the maximum operating temperature of the product by 4° C for every 100 watts dissipated in the cabinet. If the total power dissipated in the cabinet is greater than 800 watts, then forced convection must be used.

Product Markings

CE - the CE mark is a registered trademark of the European Community. A CE mark accompanied by a year indicated the year the design was proven.

CSA - the CSA mark is a registered trademark of the Canadian Standards Association.

CERTIFICATION

Hewlett-Packard Company certifies that this product met its published specifications at the time of shipment from the factory. Hewlett-Packard further certifies that its calibration measurements are traceable to the United States National Institute of Standards and Technology, to the extent allowed by the Institute's calibration facility, and to the calibration facilities of other International Standards Organization members

WARRANTY

This Hewlett-Packard instrument product is warranted against defects in material and workmanship for a period of one year from date of shipment. During the warranty period, Hewlett-Packard Company will at its option, either repair or replace products which prove to be defective.

For warranty service or repair, this product must be returned to a service facility designated by HP. Buyer shall prepay shipping charges to HP and HP shall pay shipping charges, duties, and taxes for products returned to HP from another country.

HP warrants that its software and firmware designated by HP for use with an instrument will execute its programming instructions when properly installed on that instrument. HP does not warrant that the operation of the instrument, or software, or firmware will be uninterrupted or error free.

LIMITATION OF WARRANTY

The foregoing warranty shall not apply to defects resulting from improper or inadequate maintenance by Buyer, Buyer-supplied software or interfacing, unauthorized modification or misuse, operation outside of the environmental specifications for the product, or improper site preparation or maintenance.

NO OTHER WARRANTY IS EXPRESSED OR IMPLIED. HP SPECIFICALLY DISCLAIMS THE IMPLIED WARRANTIES OF MERCHANTABILITY AND FITNESS FOR A PARTICULAR PURPOSE.

EXCLUSIVE REMEDIES

THE REMEDIES PROVIDED HEREIN ARE BUYER'S SOLE AND EXCLUSIVE REMEDIES. HP SHALL NOT BE LIABLE FOR ANY DIRECT, INDIRECT, SPECIAL, INCIDENTAL, OR CONSEQUENTIAL DAMAGES, WHETHER BASE ON CONTRACT, TORT, OR ANY OTHER LEGAL THEORY.

ASSISTANCE

Product maintenance agreements and other customer assistance agreements are available for Hewlett-Packard products. For any assistance, contact your nearest Hewlett-Packard Sales and Service Office.

DECLARATION OF CONFORMITY

according to ISO/IEC Guide 22 and EN 45014

Manufacturer's Name: Hewlett-Packard Co.
Manufacturer's Address: Spokane Division
24001 E. Mission Avenue
Liberty Lake, Washington 99019-9599
USA

declares that the product

Product Name: TDMA, CDPD, TDMA/CDPD Cellular Adapter
Model Number: HP 83204A
Product Options: This declaration covers all options of the above product.

conforms to the following Product specifications:

Safety: IEC 1010-1:1990+A1 / EN 61010-1:1993
EMC: CISPR 11:1990 / EN 55011:1991 Group 1, Class A
EN 50082-1: 1992
IEC 801-2:1991 - 4 kV CD, 8 kV AD
IEC 801-3:1984 - 3V/m
IEC 801-4:1988 - 0.5 kV Sig. Lines, 1 kV Power Lines

Supplementary Information:

This product herewith complies with the requirements of the Low Voltage Directive 73/23/EEC and the EMC Directive 89/336/EEC and carries the CE-marking accordingly.

Spokane, Washington, USA November 5, 1996



Vince Roland
Reliability & Regulatory
Engineering Manager

European Contact: Your local Hewlett-Packard Sales and Service Office or Hewlett-Packard GmbH
Department ZQ/Standards Europe, Herrenberger Strasse 130, D-71034 Böblingen, Germany (FAX+49-7031-14-3143)

HP Support Contacts

The documentation supplied with your test set is an excellent source of reference, applications, and service information. Please use these manuals if you are experiencing technical problems:

- Operations information is included in the HP 83204A Cellular Adapter User's Guide (HP P/N 83204-90009).
- Operations information is included in the HP 83204A Cellular Adapter Software User's Guide (HP P/N 83204-90014).
- For information about servicing the Test Set refer to the HP 83204A Cellular Adapter Assembly Level Repair Manual (HP P/N 83204-90018).

If you have used the manuals and still have *application* questions, contact your local HP Sales Representative.

Repair assistance is available for the HP 83204A Cellular Adapter from the factory by phone and e-mail. Internal Hewlett-Packard users can contact the factory through HPDesk or cc:Mail© (Lotus Corporation). Parts information is also available from Hewlett-Packard.

When calling or writing for repair assistance, please have the following information ready:

- Instrument model number (HP 83204A)
- Instrument Serial Number (tag located on the rear panel).
- Installed options - if any (tag located on the rear panel).
- To verify instrument firmware revisions refer to chapter 4, "Modifications," on page 99.

Support Telephone Numbers:

- 1 800 827 3848 (Spokane Division Service Assistance, U.S. only)
- 1 509 921 3848 (Spokane Division Service Assistance, International)
- 1 800 227 8164 (HP Direct Parts Ordering, U.S. only)
- 1 916 783 0804 (HP Service Parts Identification, U.S. & Intl.)

Electronic mail (Internet): Spokane_Service@spk.hp.com

HP Desk: Spokane Service / HP1000/21

cc:Mail: SERVICE, SPOKANE /HP-Spokane,desk1

Table 1 Regional Sales and Service Offices

<p>United States of America U.S. Instrument Support Center For Test & Measurement Equipment Repair & Calibration Hewlett-Packard Company Englewood, Colorado 80112</p> <p>Telephone: (800) 403-0801 Fax: (888) 857-8161</p>	<p>United States of America Customer Information Center For Assistance On All HP Products Hewlett-Packard Company Tel: (800) 752-0900</p> <p>6:00 am to 5:00 pm Pacific Time Parts Direct: (800) 227-8164</p>	
<p>South Eastern Europe Sales and Service Hewlett-Packard Ges. m.b.h. Liebigasse 1 P.O. Box 72 A-1222 Vienna, Austria</p> <p>Telephone: 43 222 2500 0 Telex: 13 4425</p>	<p>European Multicountry Region Sales and Service Hewlett-Packard S.A. P.O. Box 95 150, Route dv Nant_dl_AVRIL CH-1217 Meyrin 2 Geneva, Switzerland</p> <p>Telephone: (41/22) 780-8111 Fax: (41/22) 780-8542</p>	<p>Northern Europe Sales and Service Hewlett-Packard Nederland B.V. Startbaan 16 1187 XR Amstelveen, The Netherlands P.O. Box 667</p> <p>Telephone: 31/20 5476911 X 6631 Fax: 31-20-6471825NL</p>
<p>Asia Sales and Service Hewlett-Packard Asia Ltd. 22-30/F Peregrine Tower Lippo Center 89 Queensway, Central Hong Kong G.P.O. Box 863 Hong Kong</p> <p>Telephone: 852-848-7777 Fax: 852-868-4997</p>	<p>Japan Sales and Service Yokogawa-Hewlett-Packard Ltd. 3-29-21, Takaido-Higashi Suginami-Ku, Tokyo 168</p> <p>Telephone: 81 3 3331-6111 Fax: 81 3 3331-6631</p>	<p>International Sales Branch Headquarters Sales and Service Hewlett-Packard S.A. 39 Rue Veyrot P.O. Box 365 1217 Meyrin 1 Geneva, Switzerland</p> <p>Telephone: 41-22-780-4111 Fax: 41-22-780-4770</p>
<p>Australia, New Zealand Sales and Service Hewlett-Packard Ltd. P.O. Box 221 31-41 Joseph Street Blackburn, Victoria 3130</p> <p>Telephone: (61/3) 895-2895 Fax: (61/3) 898-9257</p>	<p>Canada Sales and Service Hewlett-Packard (Canada) Ltd. 5150 Spectrum Way Mississauga, Ontario L4W 5G1 Canada</p> <p>Telephone: (416) 206-4725 Fax: (416) 206-4739</p>	<p>Canada Service Center Hewlett-Packard Company 17500 Transcanada Highway S. Serv Road Kirkland, Quebec H9J 2X8 Canada</p> <p>Telephone: (416) 206-3295</p>

Table 1

Regional Sales and Service Offices

Canada
Service Center
Hewlett-Packard Ltd.
11120 178 Street
Edmonton, Alberta T5S 1P2
Canada

Telephone: (403) 486-6666
Fax: (403) 489-8764

Latin America
Hewlett-Packard Company
LAHQ Mexico City
Col. Lomas de Virreyes
11000 Mexico D.F.
Mexico

Telephone: (52/5) 326-4000
Fax: (52/5) 202 7718

United Kingdom
Sales and Service
Hewlett-Packard Ltd.
Cain Road
Amen Corner
Bracknell, Berkshire
RG12 1HN
United Kingdom

Telephone: 44 344 360000
Fax: 44 344 363344

Power Cables

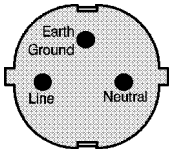
Plug Type	Plug Descriptions male/female	HP Part # (cable & plug)	Cable Descriptions
	Straight/Straight Straight/90°	8120-1689 8120-1692	79 inches, mint gray 79 inches, mint gray
Used in the following locations			
Afghanistan, Albania, Algeria, Angola, Armenia, Austria, Azerbaijan, Azores			
Bangladesh, Belgium, Benin, Bolivia, Bosnia-Herzegovina, Bulgaria, Burkina Faso, Burma, Burundi, Byelarus			
Cameroon, Canary Islands, Central African Republic, Chad, Chile, Comoros, Congo, Croatia, Czech Republic, Czechoslovakia			
Denmark, Djibouti			
East Germany, Egypt, Estonia, Ethiopia			
Finland, France, French Guiana, French Indian Ocean Areas			
Gabon, Gaza Strip, Georgia, Germany, Gozo, Greece			
Hungary			
Iceland, Indonesia, Iran, Iraq, Israel, Italy, Ivory Coast			
Jordan			
Kazakhstan, Korea, Kyrgystan			
Latvia, Lebanon, Libya, Lithuania, Luxembourg			
Macedonia, Madeira Islands, Malagasy Republic, Mali, Malta, Mauritania, Miquelon, Moldova, Mongolia, Morocco, Mozambique			
Nepal, Netherlands, Netherlands Antilles, Niger, Norway			
Oman			
Pakistan, Paraguay, Poland, Portugal			
Rep. South Africa, Romania, Russia, Rwanda			
Saudi Arabia (220V), Senegal, Slovak Republic, Slovenia, Somalia, Spain, Spanish Africa, Sri Lanka, St. Pierre Islands			
Sweden, Syria			
Tajikistan, Thailand, Togo, Tunisia, Turkey, Turkmenistan			
USSR, Ukraine, Uzbekistan			
Western Africa, Western Sahara			
Yugoslavia			
Zaire			

Plug Type	Plug Descriptions male/female	HP Part # (cable & plug)	Cable Descriptions
	Straight/Straight	8120-0698	90 inches, black
Used in the following locations			
Peru			

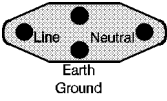
Plug Type	Plug Descriptions male/female	HP Part # (cable & plug)	Cable Descriptions
	Straight/Straight Straight/90°	8120-2104 8120-2296	79 inches, gray 79 inches, gray
Used in the following locations			
Switzerland			

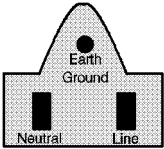
Plug Type	Plug Descriptions male/female	HP Part # (cable & plug)	Cable Descriptions
<p style="text-align: center;">125V</p> 	Straight/Straight Straight/90° Straight/Straight	8120-1378 8120-1521 8120-1751	90 inches, jade gray 90 inches, jade gray 90 inches, jade gray
Used in the following locations			
American Samoa			
Bahamas, Barbados, Belize, Bermuda, Brazil,			
Caicos, Cambodia, Canada, Cayman Islands, Columbia, Costa Rica, Cuba			
Dominican Republic			
Ecuador, El Salvador			
French West Indies			
Guam, Guatemala, Guyana			
Haiti, Honduras			
Jamaica			
Korea			
Laos, Leeward and Windward Is., Liberia			
Mexico, Midway Islands			
Nicaragua			
Other Pacific Islands			
Panama, Philippines, Puerto Rico			
Saudi Arabia (115V, 127V), Suriname			
Taiwan, Tobago, Trinidad, Trust Territories of Pacific Islands			
Turks Island			
United States			
Venezuela, Vietnam, Virgin Islands of the US			
Wake Island			

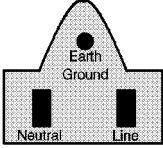
Plug Type	Plug Descriptions male/female	HP Part # (cable & plug)	Cable Descriptions
JIS C 8303, 100 V 	Straight/Straight Straight/90°	8120-4753 8120-4754	90 inches, dark gray 90 inches, dark gray
Used in the following locations			
Japan			

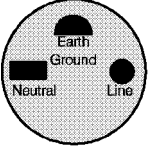
Plug Type	Plug Descriptions male/female	HP Part # (cable & plug)	Cable Descriptions
	90°/Straight 90°/90° Straight/Straight	8120-2956 8120-2957 8120-3997	79 inches, gray 79 inches, gray 79 inches, gray
Used in the following locations			
Denmark			
Greenland			

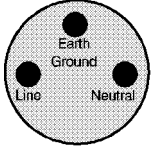
Plug Type	Plug Descriptions male/female	HP Part # (cable & plug)	Cable Descriptions
	Straight/Straight Straight/90°	8120-4211 8120-4600	79 inches, mint gray 79 inches, mint gray
Used in the following locations			
Botswana			
India			
Lesotho			
Malawi			
South-West Africa (Namibia), Swaziland			
Zambia, Zimbabwe			

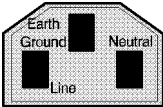
Plug Type	Plug Descriptions male/female	HP Part # (cable & plug)	Cable Descriptions
	Straight/Straight Straight/Straight Straight/90° Straight/90°	8120-1860 8120-1575 8120-2191 8120-4379	60 inches, jade gray 30 inches, jade gray 60 inches, jade gray 15.5 inches, jade gray
Used in the following locations			
System Cabinets			

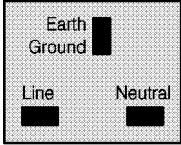
Plug Type (Male)	Plug Descriptions male/female	HP Part # (cable& plug)	Cable Descriptions
	90°/Straight 90°/90°	8120-1351 8120-1703	90 inches, mint gray 90 inches, mint gray
Used in the following locations			
Bahrain, British Indian Ocean Terr., Brunei			
Canton, Cyprus			
Enderbury Island, Equatorial Guinea			
Falkland Islands, French Pacific Islands			
Gambia, Ghana, Gibraltar, Guinea			
Hong Kong			
Ireland			
Kenya, Kuwait			
Macao, Malaysia, Mauritius			
Nigeria			
Qatar			
Seychelles, Sierra Leone, Singapore, SouthernAsia, Southern Pacific Islands, St. Helena, Sudan			
Tanzania			
Uganda, United Arab Emirates, United Kingdom			
Yeman (Aden & Sana)			

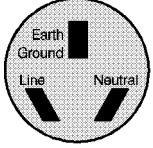
Plug Type	Plug Descriptions male/female	HP Part # (cable & plug)	Cable Descriptions
	Straight/Straight Straight/90°	8120-1369 8120-0696	79 inches, gray 80 inches, gray
Used in the following locations			
Argentina, Australia			
China (People's Republic)			
New Zealand			
Papua New Guinea			
Uruguay			
Western Samoa			

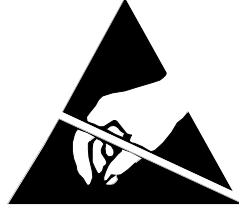

ATTENTION

Static Sensitive Devices

This instrument was constructed in an ESD (electro-static discharge) protected environment. This is because most of the semi conductor devices used in this instrument are susceptible to damage by static discharge.

Depending on the magnitude of the charge, device substrates can be punctured or destroyed by contact or mere proximity of a static charge. The result can cause degradation of device performance, early failure, or immediate destruction.

These charges are generated in numerous ways such as simple contact, separation of materials, and normal motions of persons working with static sensitive devices.

When handling or servicing equipment containing static sensitive devices, adequate precautions must be taken to prevent device damage or destruction.

Only those who are thoroughly familiar with industry accepted techniques for handling static sensitive devices should attempt to service circuitry with these devices.

In all instances, measures must be taken to prevent static charge build-up on work surfaces and persons handling the devices.

In this Book

This manual contains the following information to help you repair, calibrate, and verify correct operation of the HP 83204A Cellular Adapter.

Chapter 1, Introduction

This chapter provides a general description of the Cellular Adapter and general information concerning troubleshooting, repair, and calibration of the Cellular Adapter. HP service and support information is also provided.

Chapter 2, Troubleshooting

The procedures for isolating a failure to the faulty assembly is discussed in this chapter. The Cellular Adapter's automated diagnostics are described. The descriptions help you understand what has been checked by the diagnostics in case the diagnostics cannot identify a probable failure and you must troubleshoot further.

Chapter 3, Disassembly and Replacement

This chapter provides procedures and illustrations for disassembly of the Cellular Adapter.

Chapter 4, Modifications

This chapter explains how to verify the firmware in the Cellular Adapter and how to upgrade firmware.

Chapter 5, Block Diagrams

Diagrams are provided illustrating the general operation of the major sections of the Cellular Adapter. The diagrams provide detailed illustrations of each assembly, including signal functions and connector pin numbers. This information is used to better understand the operation of the Cellular Adapter when manually troubleshooting it (in case the automated diagnostics cannot identify a faulty assembly with high confidence).

Chapter 6, Replaceable Parts

Contains illustrations for identifying the various assemblies and components of the Cellular Adapter. Part numbers for each replaceable part are provided.

Chapter 7, Periodic Calibration and Performance Test

Contains Cellular Adapter performance tests and periodic calibration procedures.

Chapter 8, Specifications

Lists the warranted specifications of the Cellular Adapter.

Conventions Used In This Manual

The HP 83204A TDMA (Option 001), HP 83204A CDPD (Option 002), or the HP 83204A TDMA/CDPD (Option 003) Cellular Adapter is referred to as the Cellular Adapter.

The HP 8921A Cell Site Test Set is referred to as the Test Set.

The Cellular Adapter combined with the Test Set is referred to as the Test System.

Other Manuals Required

In troubleshooting the Cellular Adapter it may be necessary to use:

HP 8920 ALR Manual (08920-90168)

HP 83204A Cellular Adapter Software User's Guide (83204-90014)

HP 83204A User's Guide (83204-90009)

Contents

1 Introduction

Instrument Description 36

TDMA Cellular Adapters 39

CDPD Cellular Adapters 40

Troubleshooting 41

Repair Process 41

Periodic Calibration and Performance Tests 42

Service Tools and Equipment 43

Equipment 43

Tools 43

User's Guides 44

HP 83204A TDMA (Option 001/003) 44

Service Information 45

Test Set Documentation 45

Factory Support 45

Ordering Parts 45

Contents

Troubleshooting	2
Test System Troubleshooting	48
Power-Up Diagnostics	52
Test System Power-Up Diagnostics	52
Cellular Adapter Power-Up Diagnostics	52
TDMA Troubleshooting	57
DMC_DIAGL Diagnostic Program & Procedure	58
DMC_DIAGL Tests Descriptions	61
DMC_DIAGN Diagnostic Program & Procedure	62
DMC_DIAGN Tests Descriptions	65
CDPD Troubleshooting	66
CDPD_DIAG Diagnostic Program & Procedure	67
CDPD_DIAG Tests Descriptions	69

Contents

3

Disassembly and Replacement

Disassembly of the HP 83204A Cellular Adapter 74

Separating Units and Removing Cover 75

Operation Without Cover 77

Removing the A8 Power Supply Assembly 78

Disconnecting Subassembly Power Connectors 79

Removing the Front Panel 80

Removing the Back Panel 82

Removing the A4 Assembly 84

Removing the A9 Assembly 86

Removing the A4 and A9 Assemblies as a Unit 89

Removing the A10 Assembly and Semi-Rigid Cables 91

Removing the A11 Assembly 93

Removing the A2 and A5 Assemblies 94

Removing the A3 Assembly 97

Contents

Modifications	4
Firmware Upgrades	100
Firmware Loading and Verification Procedures	101
Loading RX DSP Firmware	102
Loading TX DSP Firmware	103
Loading CDPD Firmware	104
Verifying Firmware Version	105

Contents

5

Block Diagrams

Instrument Description 108

TDMA Cellular Adapter 109

TDMA Analysis 110

TDMA Generation 110

CDPD Cellular Adapter 111

CDPD Analysis 111

CDPD Generation 111

Assembly Descriptions 113

A2 RX DSP Assembly 115

A3 Motherboard 115

A4 Premodulation Filter Assembly 115

A5 TX DSP Assembly 117

A8 Power Supply 117

A9 Reference I/Q Assembly 118

A10 Directional Coupler & Serial Switch 122

A11 CDPD Assembly 122

Power Supply and Voltage Distribution 124

Contents

	6
Replaceable Parts	
Parts Identification	128
Major Assemblies	128
CDPD Components	129
External Cables	130
Front Panel Components	131
Cover and Back Panel Components	132
Back Panel Components	133
A8 Assembly & Miscellaneous Components	134
A4 Assembly and Components	135
A9 Assembly	137
A10 Assembly, Options 002 & 003	138
A11 Assembly, Options 002 & 003	139
A2 Assembly	140
A5 Assembly	141
A3 Assembly	142
Replaceable Parts List	143

7

Calibration and Performance Tests

Introduction 148

Periodic Self Calibration 149

PER_CALD Calibration Procedure 149

TDMA Performance Test Procedures 150

Special Test Equipment 150

TDMA Analyzer Accuracy Performance Test 1 151

TDMA Generator Accuracy Performance Test 2 157

CDPD Performance Test 162

Description 162

Equipment Set Up 162

Procedure 162

TDMA Performance Tests Record 168

TDMA Performance Test 1 Analyzer EVM Measurement 168

TDMA Performance Test 2 Generator EVM Measurement 168

CDPD Performance Test Record 169

CDPD Generator Spectral Purity Measurement 169

CDPD Modulation Accuracy Measurement 169

CDPD Generator On/Off Level Measurement 169

Contents

Specifications	8
HP 83204A TDMA Specifications	172
TDMA Signal Generator	172
TDMA Analyzer	173
HP 83204A CDPD Specifications	174
CDPD Signal Generator	174
CDPD Analyzer	175
Physical Specifications	176

Contents

Index 177

Contents

Introduction

This chapter contains a general description of the HP 83204A Cellular Adapter, and troubleshooting, calibration, equipment, documentation, and servicing information.

Instrument Description

The HP 83204A Cellular Adapter (see [figure 1](#)) is an accessory to the HP 8921A Cell Site Test Set. The Cellular Adapter and Test Set are connected together via front-panel and rear-panel cables and work together as a system. The Cellular Adapter adds digital signal generation and analysis to the Test Set's analog capabilities.

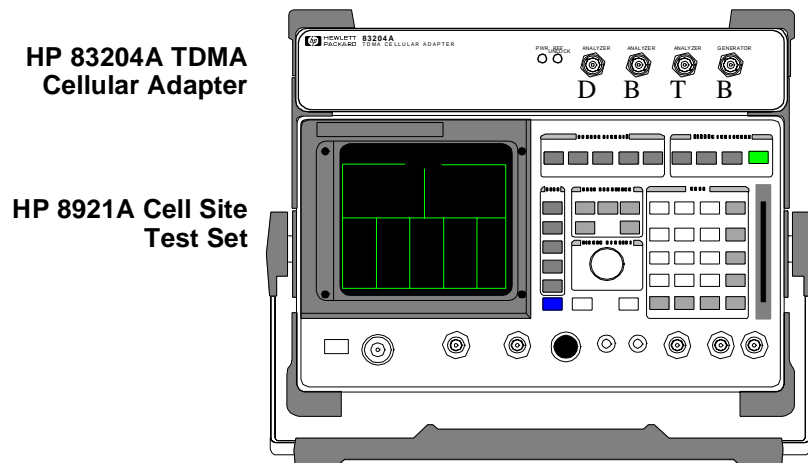

Figure 1 HP 83204A TDMA Cellular Adapter and HP 8921A Cell Site Test Set

The HP 83204A Cellular Adapter can be configured as one of three different options (see [figure 2 on page 37](#)):

- HP 83204A TDMA Cellular Adapter, Option 001
- HP 83204A CDPD Cellular Adapter, Option 002
- HP 83204A TDMA/CDPD Cellular Adapter, Option 003

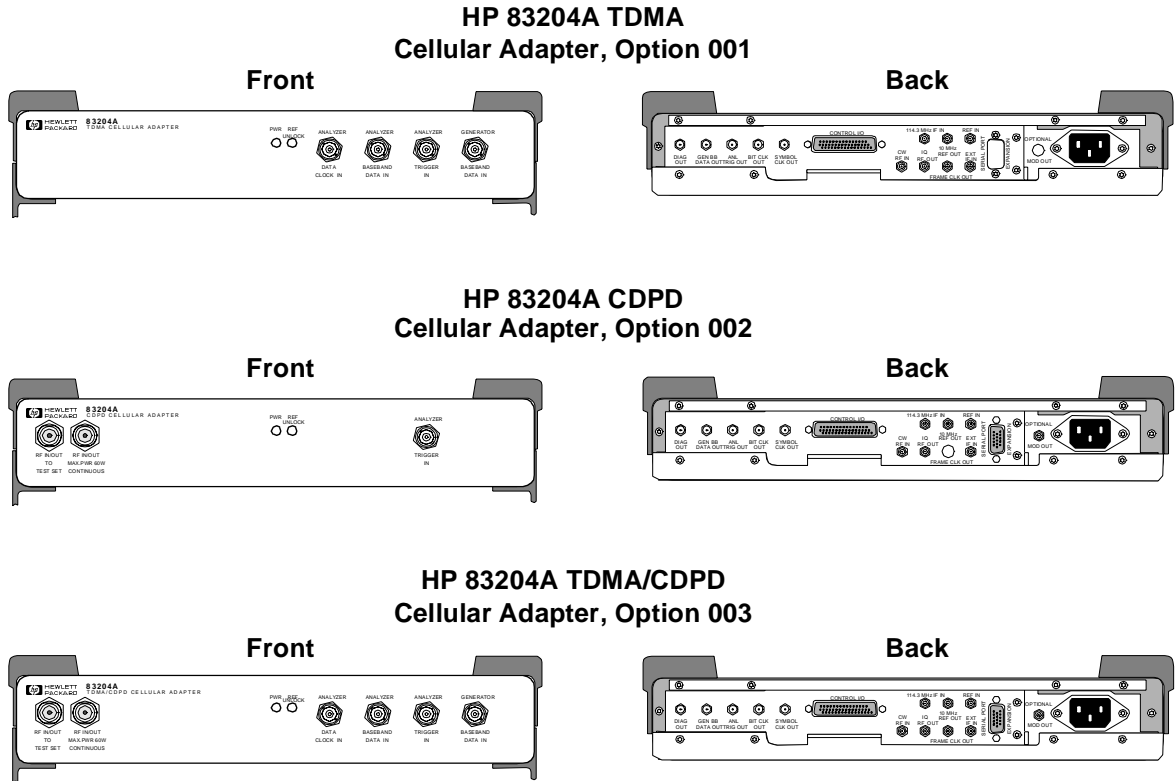

Figure 2 HP 83204A Cellular Adapter Options

Each Cellular Adapter has the following major assemblies:

- A2 RX DSP (Receiver Digital Signal Processing)
- A3 Motherboard
- A4 Premod Filter
- A5 TX DSP (Transmitter Digital Signal Processing - in Cellular Adapter Options 001 & 003 only)
- A8 Power Supply
- A9 I/Q Modulator/Reference (see following note)
- A11 CDPD processor (in Cellular Adapter Options 002 & 003 only)

NOTE:

The A9 assembly includes the A6 LO/IF and A7 I/Q Modulator assemblies.
These assemblies cannot be separately replaced.

TDMA Cellular Adapters

The HP 83204A TDMA Cellular Adapter, Option 001, and the HP 83204A TDMA/CDPD Cellular Adapter, Option 003, include DSP (Digital Signal Processing) hardware and firmware to test the transmitter and receiver portions of Time Division Multiple Access (TDMA) base stations. Systems using the TDMA format use encoders and decoders to digitize speech and add call processing information.

TDMA digital cellular systems use frequency channelization (comparable to current analog systems with 30 kHz spacing) and time domain multiplexing to increase system capacity. Each channel is shared in time by up to three users.

For transmitting, TDMA uses:

- Vector Sum Excited Linear Predictive (VSELP) speech coder
- A channel coder
- $\pi/4$ Differential Quadrature Phase Shift Keying ($\pi/4$ DQPSK) modulator
- Filter and RF amplifier

The VSELP speech coder uses VSELP coding to digitize speech, using complex algorithms to minimize the amount of data needed to represent the voice information. The channel coder adds TDMA data for channel coding, such as the phone's subscriber number, the channel (frequency) to use, etc. The $\pi/4$ DQPSK modulator provides $\pi/4$ differential quadrature phase shift keying modulation, using the local oscillator to up-convert the signal to the cellular frequency band. The modulated carrier is filtered, amplified, and sent to the antenna for transmission.

For receiving, TDMA uses:

- An RF tuned receiver and filter
- An I/Q demodulator
- A channel decoder
- A VSELP speech decoder

When the TDMA signal is received, the signal is filtered, down-converted to an intermediate frequency (IF), filtered again, and input to the I/Q demodulator. The demodulated data enters the channel decoder to remove the channel information. The VSELP speech decoder reconstructs the remaining data into speech.

CDPD Cellular Adapters

The HP 83204A CDPD Cellular Adapter, Option 002, and the HP 83204A TDMA/CDPD Cellular Adapter, Option 003, include Cellular Digital Packet Data (CDPD) digital signal generation and analysis.

CDPD is a packet data system which overlays the existing Advanced Mobile Phone System (AMPS) voice system. CDPD is designed for small bursts of data and is not efficient for large file transfer type applications. CDPD uses a separate base station (Mobile Data Base Station, MDDBS) and is integrated into the antenna system of a cell site. When there is no voice traffic on a designated AMPS voice channel, the MDDBS may transmit packet data to mobile end stations or fixed end stations. When AMPS voice traffic is assigned to that channel, the MDDBS must power down and reacquire communications on another designated CDPD channel if available.

The CDPD assembly (A11) found in Cellular Adapter Options 002 and 003 provides the hardware and firmware to perform the CDPD protocol processing.

Troubleshooting

The Cellular Adapter is normally sent in for service connected to its companion Test Set. The Test Set's internal ROM contains programs for verifying the Cellular Adapter's performance and for calibrating the Cellular Adapter and Test Set interface.

Diagnostic programs for servicing the Cellular Adapter also reside in the Test Set's firmware (ROM). Two types of built in diagnostics are available to aid in troubleshooting: power-up diagnostics which check the Test Set and Cellular Adapter's internal control circuitry, and TDMA and CDPD functional diagnostics which check analog and digital signal generation and analysis.

Chapter 7, "Calibration and Performance Tests" on page 147 explains the calibration and performance programs. Chapter 2, "Troubleshooting" on page 47 explains the power-up and TDMA- and CDPD-protocol diagnostics programs.

Repair Process

Repair of the Cellular Adapter consists of the following steps:

1. Isolate the fault or problem to the Cellular Adapter or the Test Set (see chapter 2, "Troubleshooting" on page 47). If the problem is with the Test Set, refer to the Test Set's Assembly Level Repair Manual (08920-90168).
2. Isolate the problem to a faulty assembly within the Cellular Adapter (see chapter 2, "Troubleshooting" on page 47).
3. Replace the faulty assembly (see chapter 3, "Disassembly and Replacement" on page 73).
4. Calibrate the Cellular Adapter by regenerating and downloading the calibration data (see chapter 7, "Calibration and Performance Tests" on page 147).
5. Verify the performance of the Cellular Adapter (see chapter 7, "Calibration and Performance Tests" on page 147).

Periodic Calibration and Performance Tests

To calibrate the Cellular Adapter run the automatic self-calibration program. This program, PER_CALD, resides in the Test Set's ROM as part of its firmware. This calibration program does not require external equipment or manual adjustments in the Cellular Adapter. Performance tests are also provided. Performance tests verify that the Cellular Adapter performs to its specifications. For calibration and performance procedures, refer to *chapter 7, "Calibration and Performance Tests" on page 147*.

**NOTE: PERIODIC
CALIBRATION
INTERVAL**

The calibration program PER_CALD (see "[Periodic Self Calibration](#)" on page 149) should be performed anytime the Cellular Adapter is disconnected and re-attached to another Test Set, after any assembly is replaced, or at least every 12 months.

**NOTE:
PERFORMANCE
TEST INTERVAL**

The performance tests in *chapter 7, "Calibration and Performance Tests" on page 147* should be performed anytime an assembly is replaced, or at least every 24 months.

Service Tools and Equipment

Equipment

External equipment is not required for the periodic calibration of the Cellular Adapter or for running the diagnostic routines. If diagnostic routines can not isolate the problem, an oscilloscope, voltmeter, and spectrum analyzer are the only test equipment usually needed for manual troubleshooting. A second Cellular Adapter/Test Set is helpful for troubleshooting performance test failures.

Tools

The following tools are needed for assembly removal and replacement:

- TX-10 Torx screwdriver
- 3/16-inch socket wrench (SMC)
- 5/16-inch open-end wrench (SMA)
- 15/64-inch open-end wrench
- 9/16-inch open-end wrench (BNC)
- 3/4-inch open-end wrench (type-N)

User's Guides

HP 83204A TDMA (Option 001/003)

The TDMA test screens and the Cellular Adapter's front and rear-panel connectors are documented in the HP 83204A TDMA Cellular Adapter User's Guide (HP part number 83204-90009).

CDPD software is documented in the HP 83204A Cellular Adapter Software User's Guide (HP part number 83204-90014).

Service Information

Test Set Documentation

The Cellular Adapter along with a Test Set form a test system. Servicing the Cellular Adapter is discussed in this manual. Servicing the Test Set is documented in the HP 8920/8921 Assembly Level Repair manual (HP part number 08920-90168).

Factory Support

Troubleshooting assistance is available for Test Sets and Cellular Adapters by e-mail (electronic mail) or telephone:

- Internet e-mail address: spokane_service@spk.hp.com
- Spokane Division Website
WWW home page - HP personnel only:<http://www.spk.hp.com>
- U.S.A. and Canada only, M-F 8-5 PM PST,
toll free:800-827-3848
- Outside North America, M-F 8-5 PM PST,
phone:509-921-3848

Ordering Parts

To order parts, calls HP Support Materials Organization (SMO):

- U.S.A only,
HP Direct Parts Ordering, phone:800-227-8164
- U.S.A and international,
HP Service Parts Identification, phone:916-783-8004

Troubleshooting

This chapter contains troubleshooting procedures for the HP 83204A Cellular Adapter.

Test System Troubleshooting

Before troubleshooting the Cellular Adapter, ensure that the Test Set is operating correctly independent of the Cellular Adapter. The Test Set has, resident in ROM, diagnostic programs to help you isolate a failure in the Test Set. These programs do not require external equipment. Refer to the HP 8920/8921 Assembly Level Repair Guide for troubleshooting procedures.

The Test Set also has, resident in ROM, diagnostic programs to help you isolate a failure in the Cellular Adapter. These programs don't require external equipment, however, external connections between the Test Set and the Cellular Adapter may be required. These diagnostic programs help isolate the most common Cellular Adapter failures to the defective assembly.

- **Power-Up Diagnostics**
Every time the Cellular Adapter is powered on, self-test diagnostics are run. A failure detected in the Cellular Adapter or Test Set by the power-up diagnostics is displayed on the Test Set's screen as an error message and code. If the problem lies in the Cellular Adapter, further investigation of the problem involves removing the cover of the Test Set to view troubleshooting LEDs within the Test Set. Details are explained later in this chapter.
- **TDMA Diagnostic Programs**
DMC_DIAGL (see page 58) and DMC_DIAGN (see page 62) are IBASIC TDMA diagnostic programs stored in the Test Set's ROM. When these programs are run, the results are displayed on the Test Set's screen. These tests compare the Cellular Adapter's TDMA current state against TDMA expected limits defined in the diagnostic software. When test measurements are not within the expected limits, the diagnostics list the assembly that has failed, and gives an indication of how certain the diagnostics are of the failure.
- **CDPD Diagnostic Programs**
CDPD_DIAG (see page 67) verifies the proper operation of the CDPD assembly in the Cellular Adapter, Options 002 and 003.

Use the flow diagram in [figure 3 on page 49](#) to assist you in troubleshooting the Cellular Adapter.

HP 83204A Cellular Adapter Troubleshooting Flow Diagram

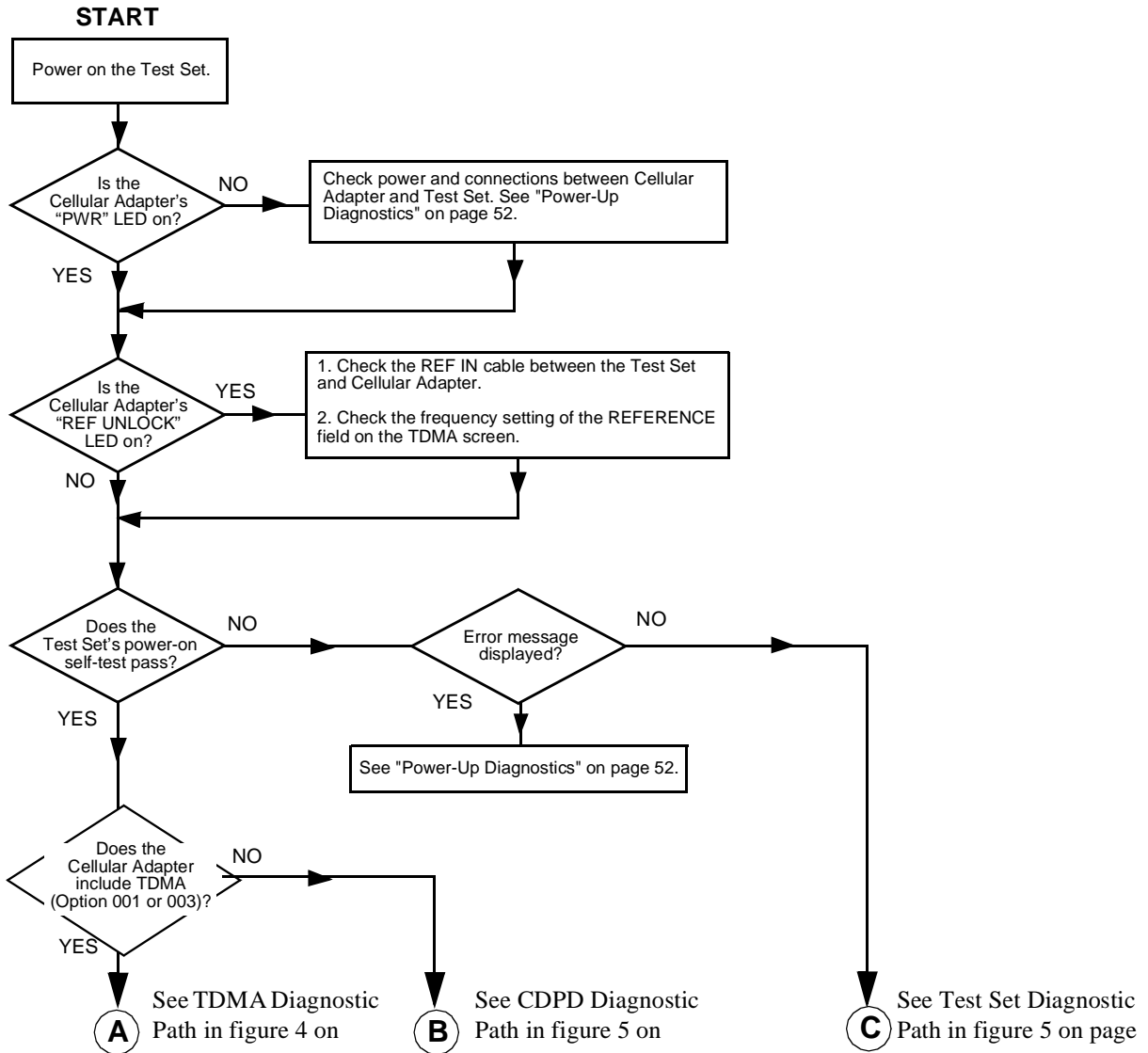

Figure 3 HP 83204A Cellular Adapter Troubleshooting Procedure

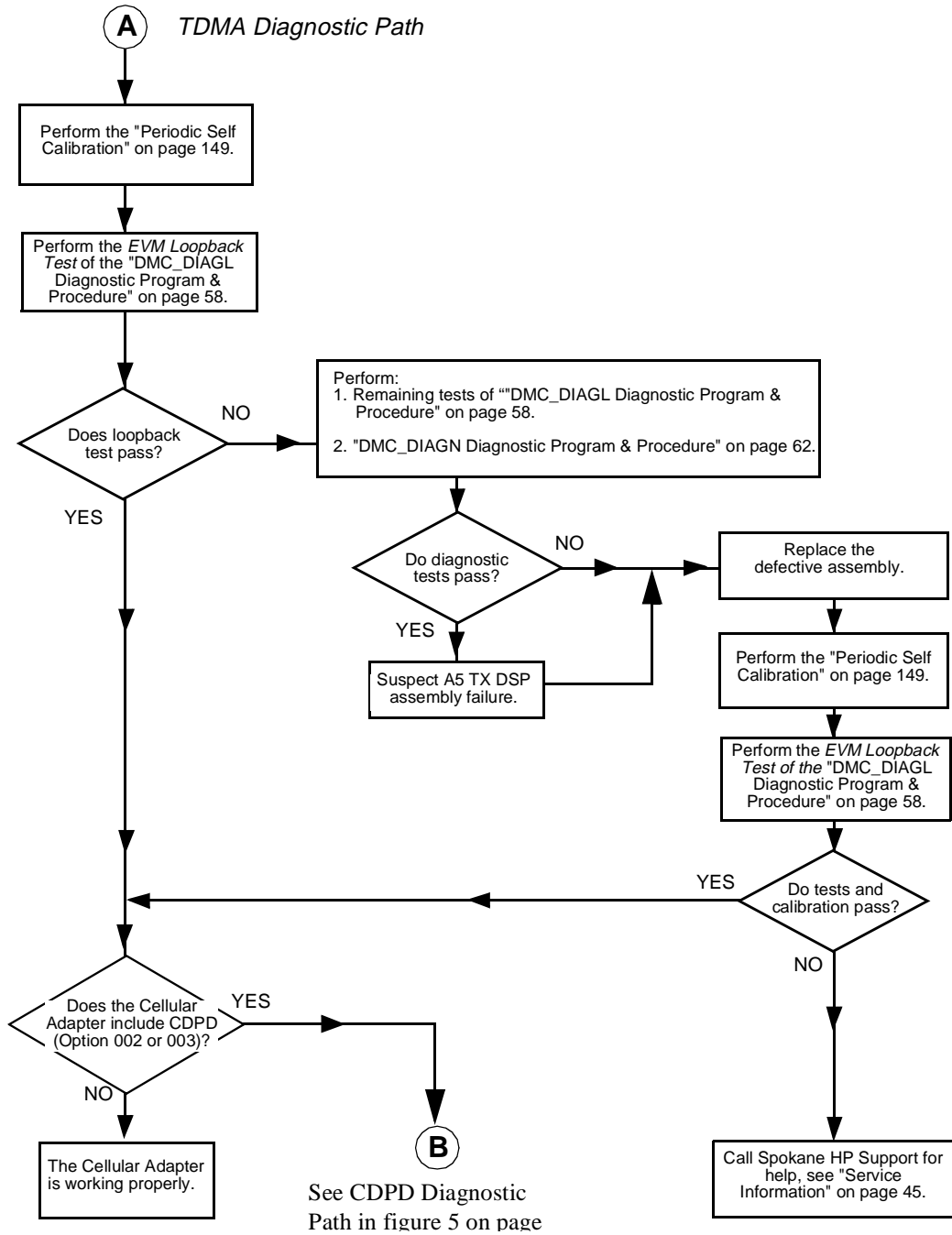

Figure 4 HP 83204A TDMA Troubleshooting Procedure

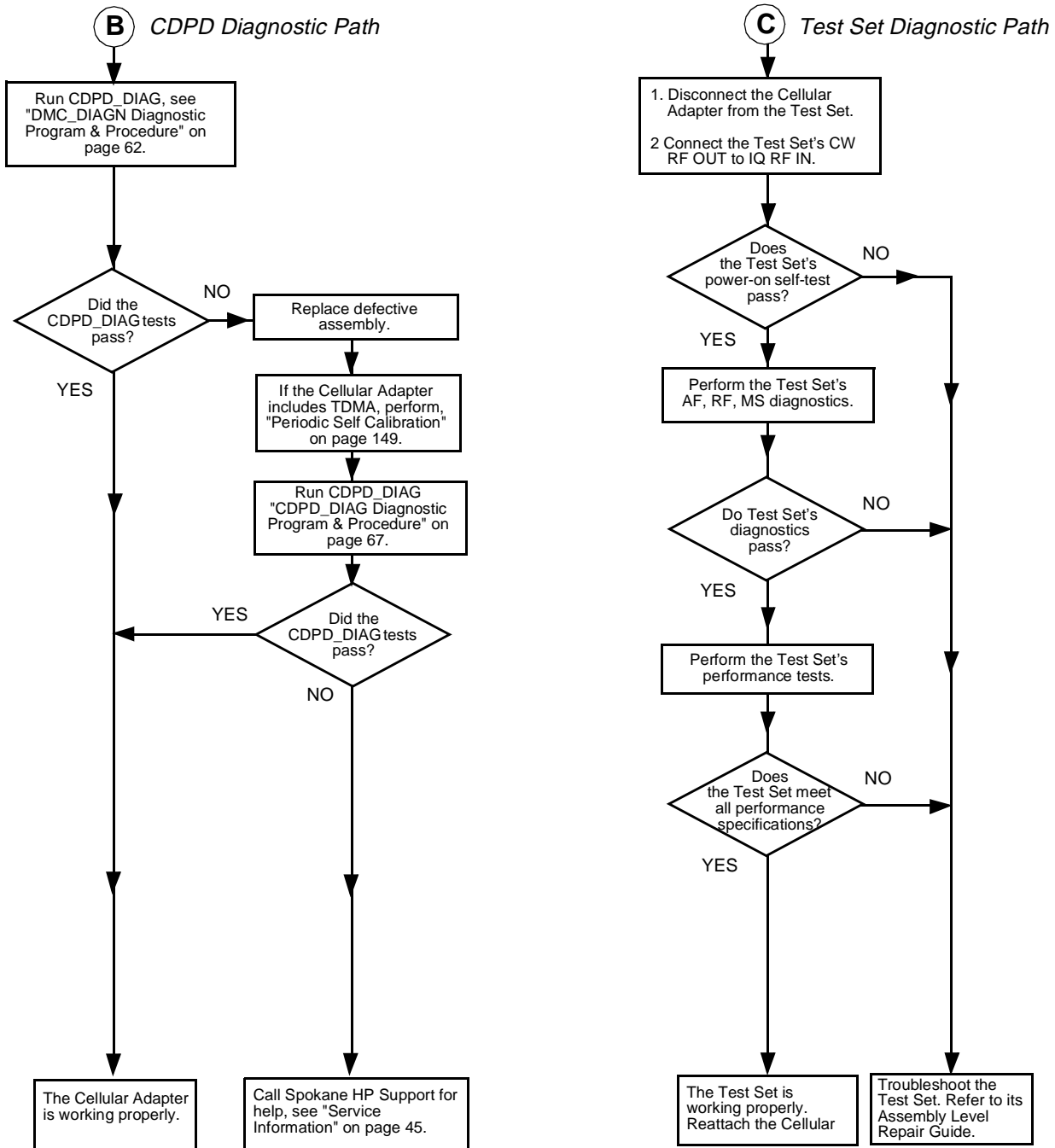

Figure 5 CDPD Cellular Adapter and HP 8921A Test Set Troubleshooting Procedure

Power-Up Diagnostics

Test System Power-Up Diagnostics

Use the table below to interpret the power-up diagnostics failure message **one or more self test failednnnn** (where nnnn is the error code). The following table gives the values for individual failures. Multiple failures produce a sum of values for individual failures.

Table 2 Power-Up Self-Test Failure Error Codes

Detect Error	Displayed Error Code
68000 Processor Failure	0002
ROM Checksum Failure	0004
Standard Non-Volatile System RAM Failure	0008
Optional Non-Volatile System RAM Failure	0010
68040 Timer Chip Failure	0020
Real-time Clock Chip Failure	0040
Keyboard Failure (stuck key)	0080
RS-232 Chip (I/O option installed and not functioning correctly)	0100
Serial Bus Communication Failure with a Standard Board	0200
Signaling Board Self-Test Failure	0400
CRT Controller Self-Test Failure	0800
Miscellaneous Hardware Failure or HP 83204A Failure ^a	1000

- a. The Cellular Adapter's only self-test error code number is 1000. However this code can also be a self-test error code number for the Test Set.

Cellular Adapter Power-Up Diagnostics

Power-up diagnostic information for the HP 83204A TDMA Cellular Adapter is only interpretable through visual observation of the LEDs on the A7 assembly of the Test Set. Observation of these LEDs requires removing the Test Set's cover. Accessing and interpreting the LEDs is explained in the following steps:

Step 1. Detach the Cellular Adapter from the Test Set.

Disconnect the cables between the Cellular Adapter and the Test Set, and then the screws shown in [figure 6](#) to detach the Cellular Adapter from the Test Set.

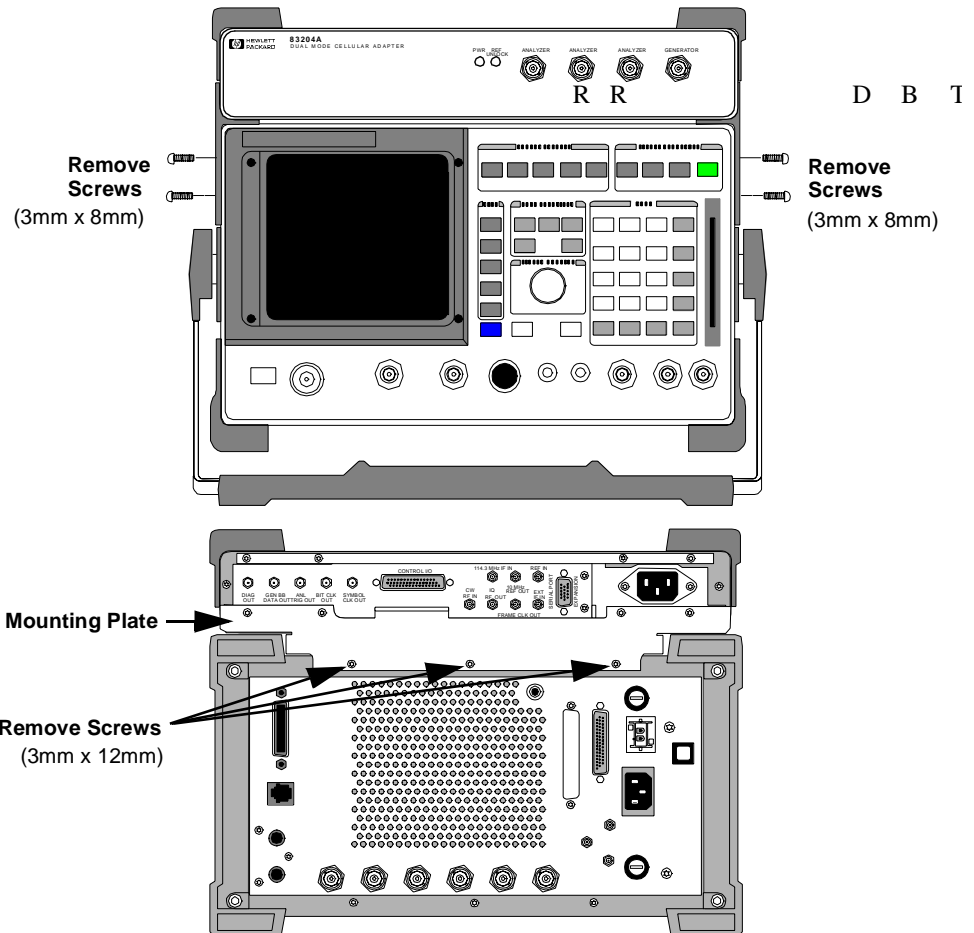

Figure 6 Detaching the Cellular Adapter

Step 2. Removing the Test Set's cover.

Refer to the HP 8920/8921 Assembly Level Repair Guide for removing the cover.

Step 3. Reconnect the cabling between the Test Set and Cellular Adapter.
See [figure 7](#) below.

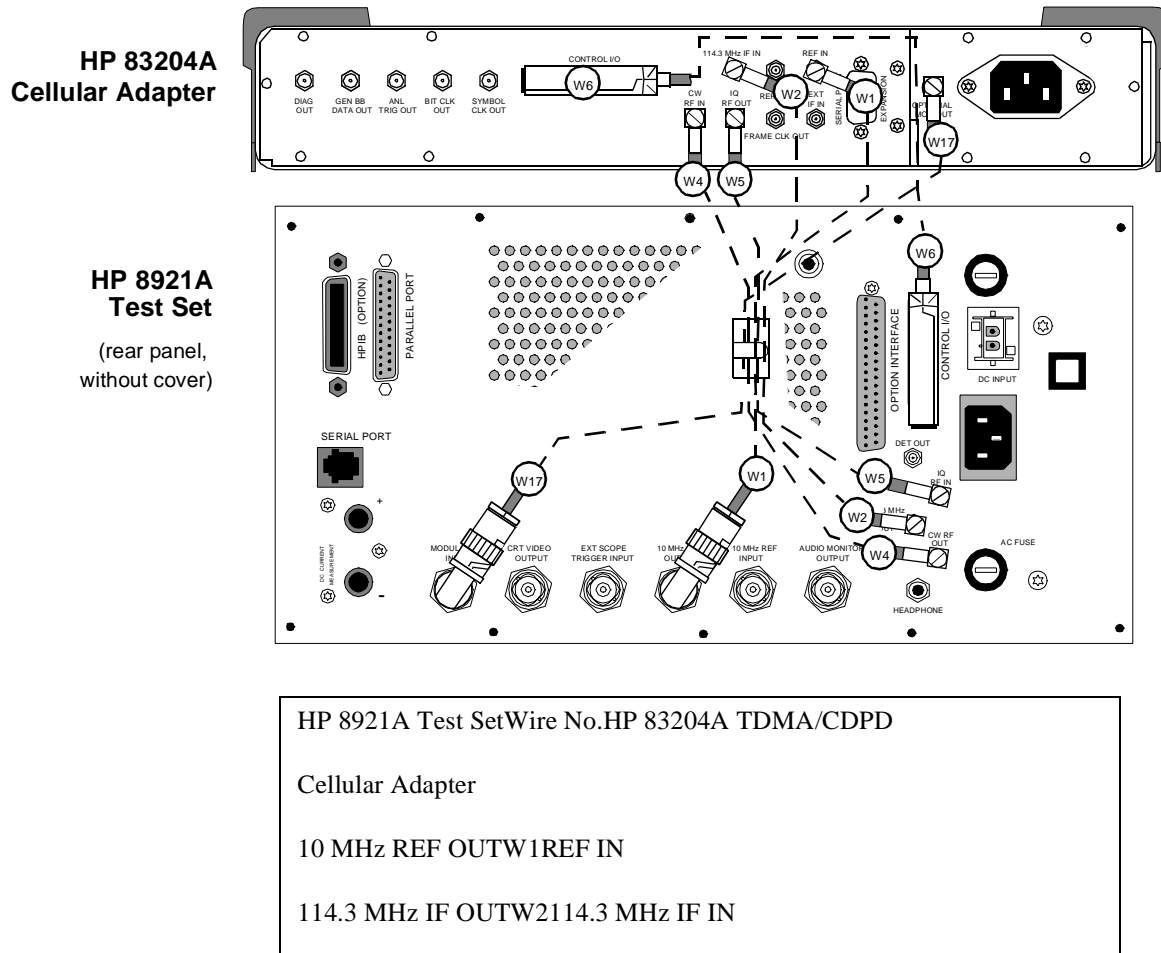

Figure 7 Test Set and Cellular Adapter (Option 001/002/003) Cabling

Step 4. Power on the Test Set. Observe and record the patterns of the LEDs on the A7 assembly of the Test Set.

See [figure 8](#) .

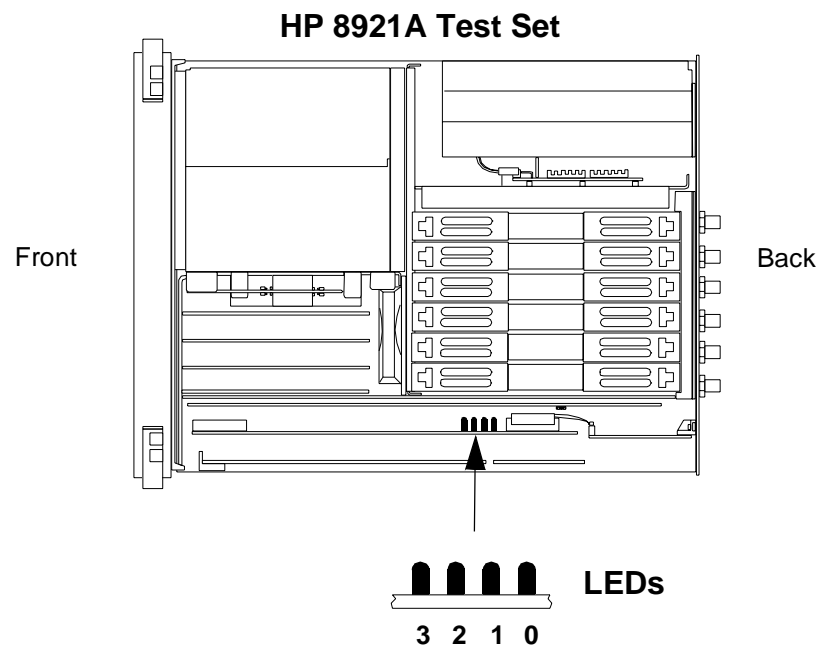





























































Figure 8 **Test Set LEDs**

Step 5. Interpret the A7 LEDs of the Test Set.

During initial power-up, all the LEDs will light for approximately 10 seconds and then turn off. If a Cellular Adapter failure is detected after initial power-up, the first LED pattern (see figure on page 56) will blink rapidly and represent a miscellaneous hardware pattern. The second and third LED patterns are non-blinking and represent failure details.

1st LED error pattern will blink rapidly and represent a miscellaneous failure...			
3 2 1 0    			
the next two LED patterns are non-blinking and represent failure details...			
if the last two non-blinking LED patterns displayed are...		...then the failure is...	
2nd LED Error Pattern	3rd LED Error Pattern		
3 2 1 0    	 3 2 1 0     3 2 1 0     3 2 1 0    	HP 83204A's (RX DSP) A2 assembly Replace this assembly.	
3 2 1 0    	 3 2 1 0    	HP 83204A's (RX DSP) A2 assembly Check firmware, see chapter 4, "Modifications" on page 99.	
3 2 1 0    	 3 2 1 0     3 2 1 0     3 2 1 0    	HP 83204A's (TX DSP) A5 assembly Replace this assembly.	
3 2 1 0    	 3 2 1 0    	HP 83204A's (TX DSP) A5 assembly Check firmware, see chapter 4, "Modifications" on page 99.	

LED Legend
 = off
 = rapid blink
 = steady on or slow blink

TDMA Troubleshooting

There are two TDMA diagnostic programs for the HP 83204A Cellular Adapter, Options 001 and 003: DMC_DIAGL and DMC_DIAGN.

DMC_DIAGL Diagnostic Program & Procedure

You must verify that the Test Set is operating correctly before this program is performed on the Cellular Adapter. The DMC_DIAGL diagnostic program performs general and global tests on the TDMA Cellular Adapter. (This diagnostic program is usually performed before the DMC_DIAGN diagnostic program.) Use **figure 9** below for making the necessary external cable connections between the Test Set and Cellular Adapter.

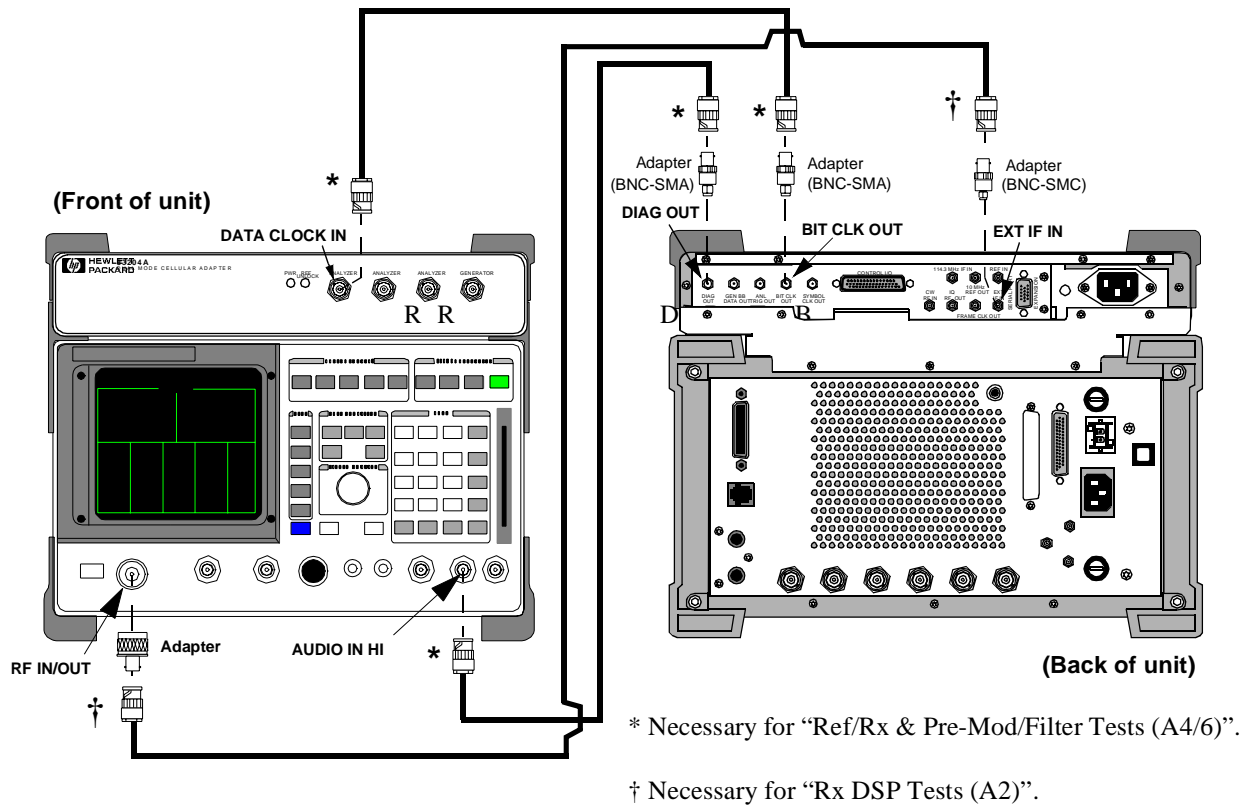

Figure 9 DMC_DIAGL Test Setup

1 - Access the TESTS (Main Menu) Screen.

Press the TESTS key. The TESTS (Main Menu) screen appears on the Test Set, see figure 10.

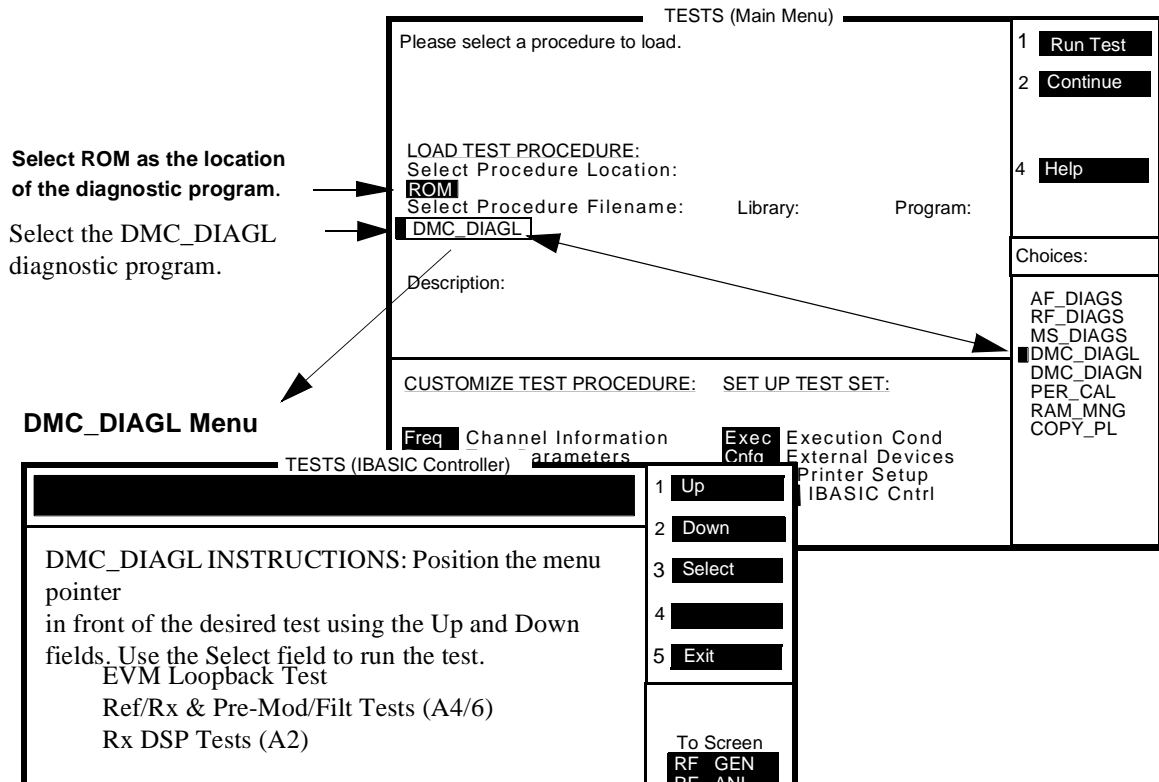

Figure 10 DMC_DIAGL Screen

2 - Select the Test Procedure.

Select ROM as procedure location of the diagnostic program, and then select DMC_DIAGL as the procedure filename. See figure 10 as reference.

3 - Run the Test Procedure.

Follow the instructions on the Test Set's display. Select one or all of the tests and press the Run Test (k1) key to run the tests. For a description of each DMC_DIAGL test, see "DMC_DIAGL Tests Descriptions" on page 61.

Interpreting the Diagnostic Test Results

Replace the assembly designated by the fault report (for an example, see **figure 11**). Use the “Probability” factor as a guideline in prioritizing the probability of failure. If more than one assembly is listed, replace one assembly at a time, from highest to lowest probability. Re-run the test procedure after each assembly replacement.

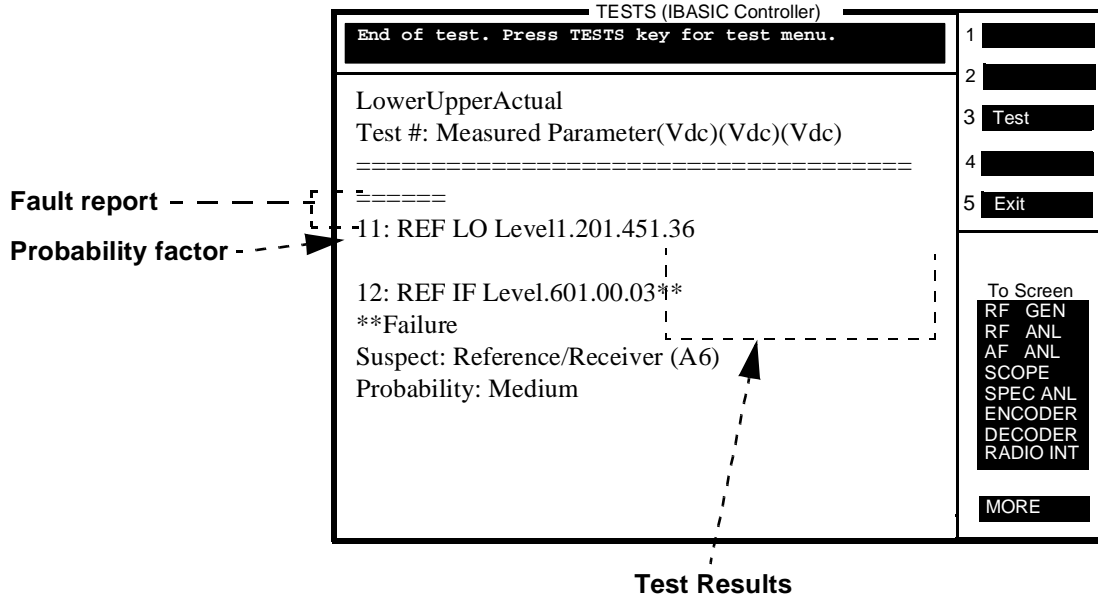

Figure 11 Interpreting Test Results for the DMC_DIAGL Tests

DMC_DIAGL Tests Descriptions

All DMC_DIAGL Tests

This routine performs the EVM Loopback Test, Ref/RX & Pre-Mod/Filter Tests, and RX DSP Tests

By connecting three external cables between the Cellular Adapter and the Test Set, all the DMC_DIAGL tests are performed without further interaction. The external cable connections (displayed on the screen when this program choice is initiated) permit the use of the “loop” option during the diagnostics. Looping is especially useful for finding intermittent or temperature related problems.

EVM Loopback Test

(Error-Vector Magnitude Loopback Test)

This routine performs a global test that exercises all the assemblies in the Cellular Adapter. An error-vector magnitude measurement is made on the received data by generating I/Q data, and internally looping that data into the Test Set’s receiver (via the Test Set’s internal splitter). No external cable connections are necessary for this test.

Ref/RX & Pre-Mod/Filt Tests (A4/A6)

(Reference/Receiver and Pre-Modulation/Filter Tests, for A4 and A6 Assemblies)

This routine tests the DC and low frequency signals available through the analog multiplexers on the Reference/Receiver and Pre-modulation/Filter assemblies. Information about the necessary cable connections is presented on the display when this test is initiated.

RX DSP Tests (A2)

(Receiver Digital Signal Processor Tests, for A2 Assembly)

This routine tests the Receiver DSP assembly of the Cellular Adapter. An error vector magnitude measurement is made on the received data by generating a 700 kHz + 3.0375 kHz (24.3/8 kHz) signal into the EXT IF IN connector to simulate an IQ-modulated signal with a data stream of all zeros. Information about necessary cable connections is presented on the display when this test is initiated.

DMC_DIAGN Diagnostic Program & Procedure

The DMC_DIAGN diagnostic program tests the individual assemblies of the Cellular Adapter. It is used as a fault isolation tool. The DMC_DIAGN program is usually performed after the DMC_DIAGL program. The DMC_DIAGN tests require several different external cable connections and do not lend themselves to a continuous looping of tests. Each DMC_DIAGN test will prompt you to make the necessary cable connections. Also, some of the DMC_DIAGN tests use the Test Set's "latch" commands which will require the Test Set's power to be cycled off and on after each test is completed.

1 - Access the TESTS (Main Menu) Screen.

Press the TESTS key. The TESTS (Main Menu) screen appears on the Test Set. See [figure 12](#) .

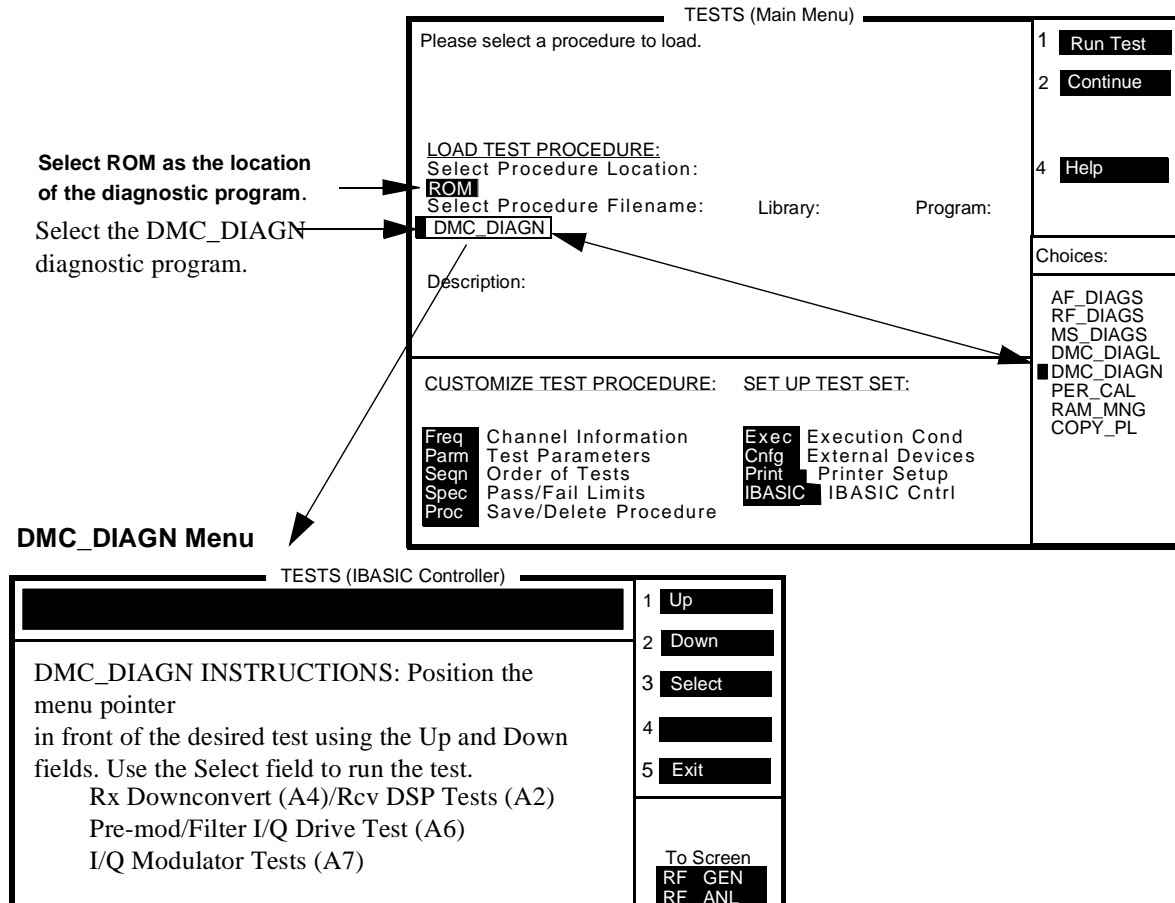

Figure 12 DMC_DIAGN Screen

2 - Select the Test Procedure.

Select ROM as procedure location of the diagnostic procedure, and then select DMC_DIAGN as the procedure filename. See [figure 12 on page 63](#).

3 - Run the Test Procedure.

Press the Run Test (k1) key to access the DMC_DIAGN screen and follow the instructions on the CRT. For a description of each diagnostic test, see ["DMC_DIAGN Tests Descriptions" on page 65](#).

Interpreting the Diagnostic Test Results.

Replace the assembly suspected as being the failure by the fault report, see [figure 13](#). Use the "Probability" factor as a guideline in prioritizing the probability of failure. If more than one assembly is listed, replace one assembly at a time, from highest to lowest probability. Re-run the test procedure after each assembly replacement.

Figure 13 Interpreting the Test Results for the DMC_DIAGN Tests

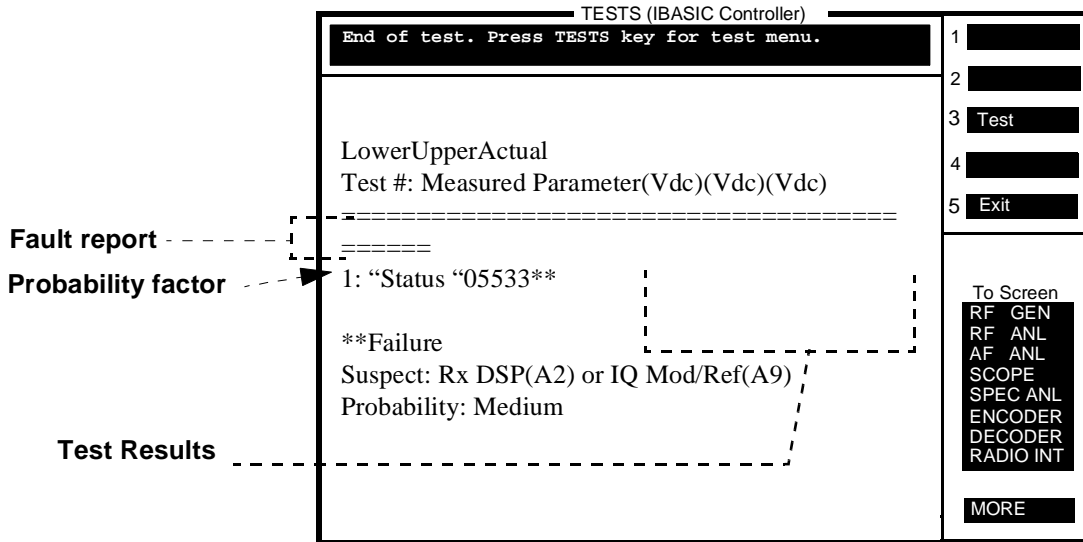

DMC_DIAGN Tests Descriptions

RX Downconvert (A4)/Rcv DSP Tests (A2)

(Receiver Downconverter [A4 Assembly] and Receiver Digital Signal Processor [A2] Assembly Tests)

This routine tests the receiver downconverter on the A4 assembly and the receiver digital signal processor on the A2 assembly. An EVM measurement is made and compared to the expected limits to verify the correct performance of the downconverter by setting the Test Set's RF generator to 114.3 MHz + 3.0375 kHz to simulate a zero bit stream pattern I/Q modulation. The Test Set's RF IN/OUT port is connect to the Cellular Adapter's 114.3 MHz IF IN port for this test procedure.

Premod/Filter I/Q Drive Test (A6)

This routine tests the I/Q modulation drive signals. The frequency of the drive signal is measured by setting up the Premod/Filter assembly's internal bits to output a stream of zeros into the modulator. The correct frequency is 3.075 kHz. The Test Set's AUDIO IN HI port is connected to the Cellular Adapter's rear panel DIAG OUT port for this test procedure.

I/Q Modulator Tests (A7)

This routine tests the I/Q and bypass paths through the I/Q modulator. The Test Set produces an 850 MHz RF signal to the I/Q modulator. In the bypass mode, the modulator's output frequency is verified to be unchanged at 850 MHz. In the I/Q mode, the Premod/Filter assembly produces a bit stream of zeros to the I/Q modulator. This results in a 3.075 kHz shift in the 850 MHz RF signal output of the I/Q modulator. This shift is then measured and verified by the Test Set's RF analyzer. The Test Set's RF IN/OUT port is connect to the Cellular Adapter's IQ RF OUT port for this test procedure.

CDPD Troubleshooting

The diagnostic software, CDPD_DIAG, resides in the ROM of the Test Set. This software tests the CDPD function of the Cellular Adapter, Option 002 or 003. The CDPD_DIAG diagnostic program consists of three tests for testing the CDPD module and its connections. Before proceeding with the CDPD diagnostic tests, you must verify that the Test Set is operating correctly.

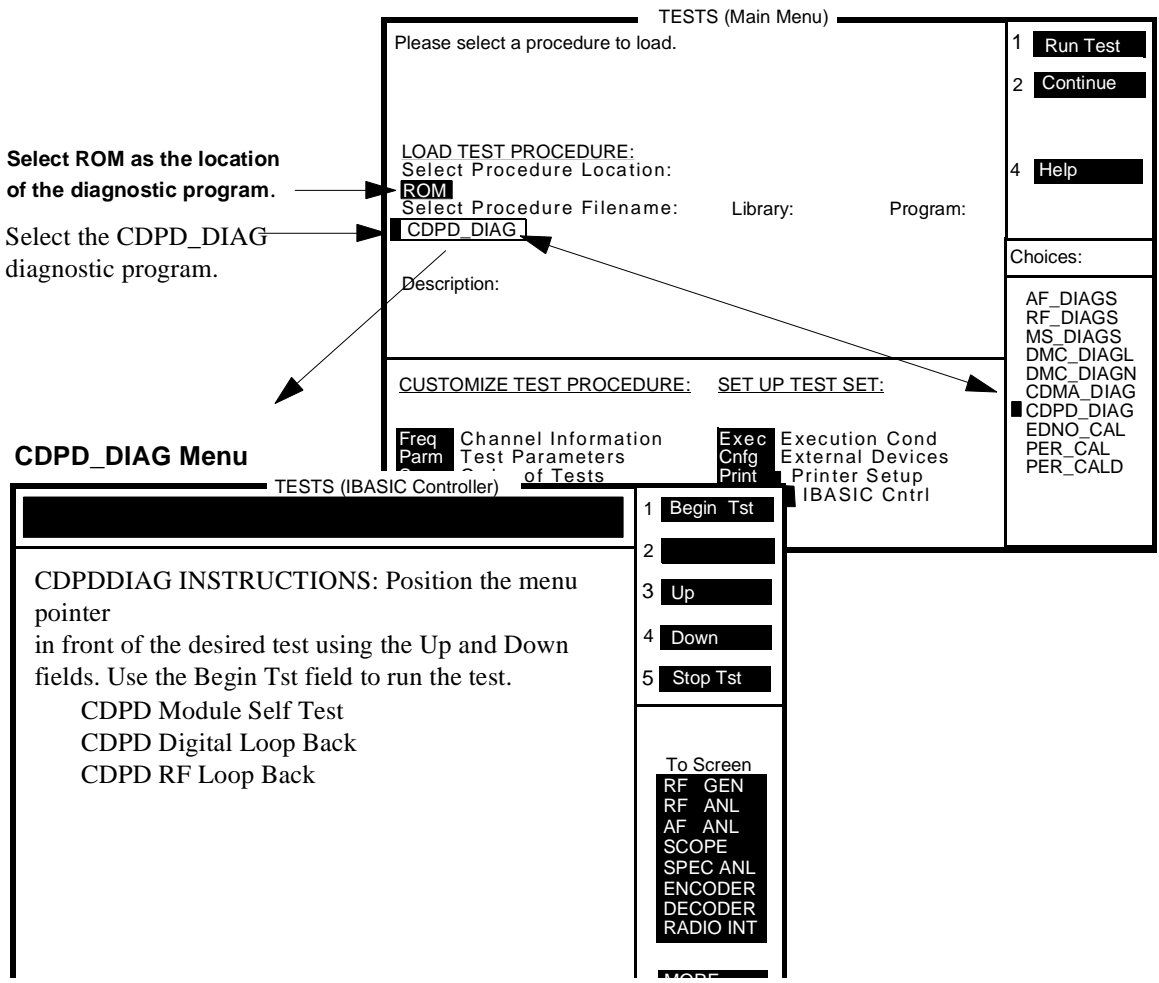

Figure 14 CDPD_DIAG Diagnostic Program

CDPD_DIAG Diagnostic Program & Procedure

To access and perform the CDPD_DIAG diagnostic program:

1. Press the TESTS key. The TESTS (Main Menu) appears, see [figure 14 on page 66](#).
2. Select **ROM** for the procedure location, and then select **CDPD_DIAG** from the **Choices:** menu for the procedure filename. See [figure 14 on page 66](#).
3. Run the CDPD_DIAG program, press k1 (**Run Test**). The CDPD test options appear, see [figure 14 on page 66](#).
4. Select **CDPD Module Self Test** and then press k1 (**Begin Tst**).

Follow the instruction displayed. If an error message is encountered, see [table 3 on page 67](#) for the probable cause of failures. If a **Tests Passed** response is received go to step 5.

5. Select **Digital Loop Back**, see [figure 14](#), and then press k1 (**Begin Tst**).

Follow the instruction displayed. If an error message is encountered, see [table 3 on page 67](#) for the probable cause of failures. If a **Valid** response is displayed go to step 6.

6. Select **CDPD RF Loop Back**, see [figure 14](#), and then press k1 (**Begin Tst**).

Follow the instruction displayed. If an error message is encountered, see [table 3 on page 67](#) for the probable cause of failures. If a **Valid** response is received, this concludes testing.

Table 3 CDPD Diagnostic Tests Error-Messages and Probable Causes

CDPD Module Self Test ^a	CDPD Digital Loop Back Test	CDPD RF Loop Back Test	Probable Cause
No response or communication time out			Check serial communication path.
SRAM failure			Failure in CDPD module (A11)
DSP failure			Failure in CDPD module (A11)
Loopback failure			Failure in CDPD module (A11)
Flash memory failure			Failure in CDPD module (A11)

Table 3 CDPD Diagnostic Tests Error-Messages and Probable Causes

CDPD Module Self Test ^a	CDPD Digital Loop Back Test	CDPD RF Loop Back Test	Probable Cause
Synthesizer failure			Failure in CDPD module (A11)
Test passed (PASS)	Unable to put into digital loopback mode.		Cycle power to clear serial bus then try again.
Test passed (PASS)	Unable to transmit.		Failure in CDPD module (A11)
Test passed (PASS)	Status NOT VALID.		Failure in CDPD module (A11)
Test passed (PASS)	PASS (status VALID)	Unable to put into normal mode.	Cycle power to clear the serial bus then try again.
Test passed (PASS)	PASS (status VALID)	Unable to transmit.	Failure in CDPD module (A11)
Test passed (PASS)	PASS (status VALID)	Unable to tune.	Failure in CDPD module (A11)
Test passed (PASS)	PASS (status VALID)	Status NOT VALID.	Faulty RF path in Cellular Adapter and Test Set, or failure in CDPD module. Refer to Chapter 5, "Block Diagrams" on page 107 to aid you in understanding and isolating the problem. ^b
PASS	PASS (status VALID)	PASS (Status VALID)	CDPD Tests successful

- a. This table assumes the diagnostic tests are performed in the order shown, that is, CDPD Module Self Test first, CDPD Digital Loop Back test second, CDPD RF Loop Back test last.
- b. If all else fails, call HP Factory Support for assistance, [see "Factory Support" on page 45.](#)

CDPD_DIAG Tests Descriptions

CDPD Module Self Test

The CDPD Module Self Test verifies the base CDPD hardware. This hardware includes the communication link between the Test Set and the CDPD module, CDPD processors, memory, synthesizer, and loopback hardware. The diagnostic program will respond with “TESTS PASSED” or a failure message indicating which part of the diagnostic routine failed, see [table 3 on page 67](#) for error messages and probable causes.

CDPD Digital Loop Back

The digital loop back test goes one step further than the self test and verifies some of the functions of the CDPD module (A11 assembly). The CDPD assembly is set to operate in the digital loopback mode when three predefined messages are sent and then received and checked for a valid CDPD signal. This is all done in the digital portion of the CDPD module. The RF circuits on the CDPD module and the RF path through the rest of the Test Set are not checked with this test.

If all three messages are successfully looped back, then the user is notified that CDPD status was VALID for all digital loops. If any one of these messages is not successfully received or is corrupted, then the program stops and notifies the user that the CDPD status was NOT VALID for the digital loop back test, and a failure message is displayed indicating which part of the test failed. See [table 3 on page 67](#) for error messages and probable causes.

RF Loop Back

The RF loop back test is similar to the digital loop back test except that the CDPD module is used in normal mode and the entire RF path through the Test System (Test Set and Cellular Adapter) is verified. Three predefined messages are sent, then received, and checked for a valid CDPD signal. This test checks the function of the CDPD module and the RF path through the Test Set.

If all three messages are successfully looped back, then the user is notified that CDPD status was VALID for all digital loops. If any one of these messages is not successfully received or is corrupted, then the program stops and notifies the user that the CDPD status was NOT VALID for the RF loop back test, and a failure message is displayed indicating which part of the RF loop failed. See [table 3 on page 67](#) for error messages and probable causes. See [figure , "CDPD RF Loop Back Test Path," on page 71](#), for a diagram of the loop back test path.

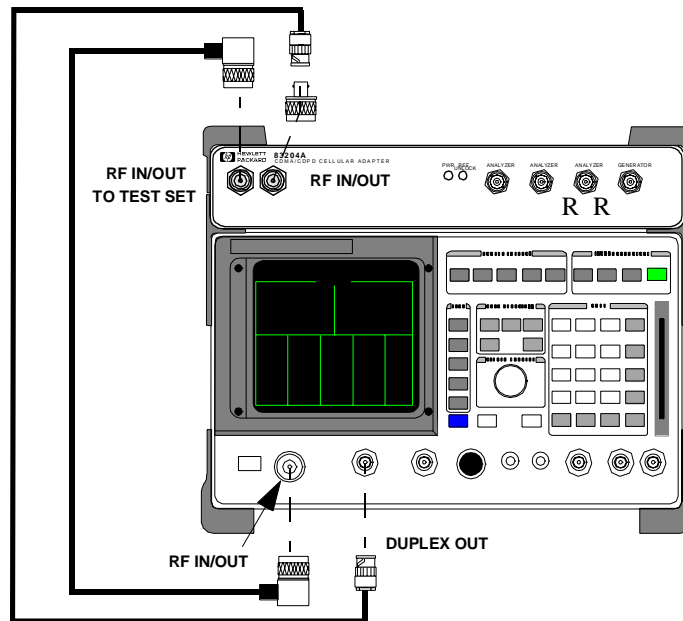
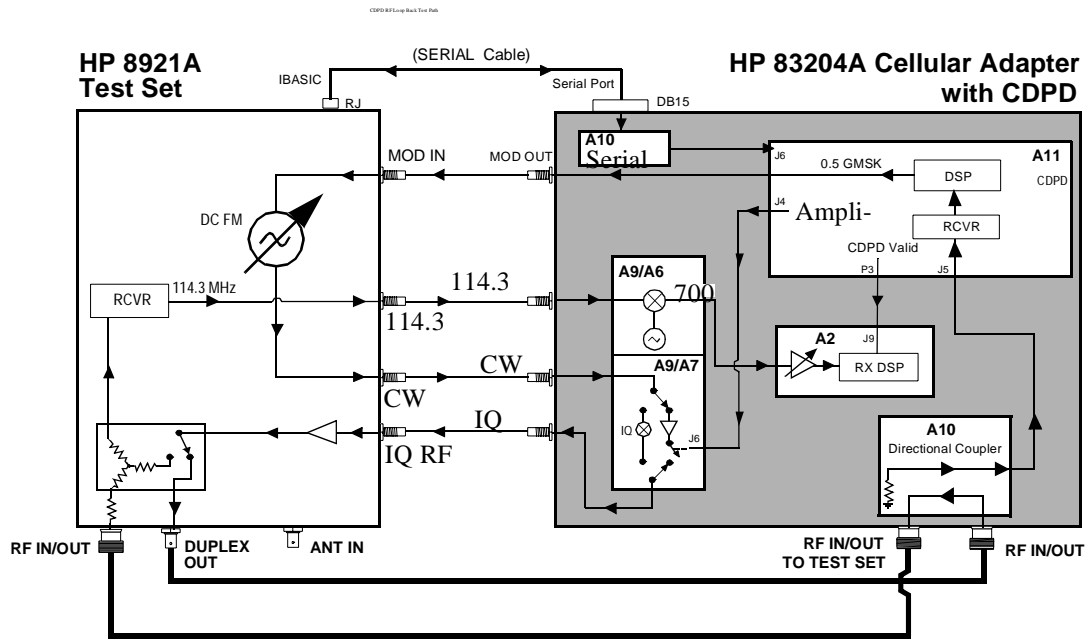

D B T B

Disassembly and Replacement

This chapter explains how to disassemble the HP 83204A TDMA/CDPD Cellular Adapter, Option 003, for the purpose of replacing failing assemblies. The following instructions are applicable to Options 001 and 002 of the Cellular Adapter. However, Option 001 will not have the CDPD assemblies and Option 002 will not have some of the TDMA assemblies.

Disassembly of the HP 83204A Cellular Adapter

Use [table 4](#) below to help you access the main assemblies and subcomponents of the Cellular Adapter.

NOTE: This chapter uses the HP 83204A TDMA/CDPD Cellular Adapter (Option 003) for disassembly. Options 001 and 002 are similar, however, Option 001 will not contain CDPD assemblies and Option 002 will not have some of the TDMA assemblies.

Table 4 TDMA Cellular Adapter Disassembly Table

To...	see...
remove the adapter's cover...	"Separating Units and Removing Cover" on page 75.
operate the adapter without its cover...	"Operation Without Cover" on page 77.
remove the A8 power supply...	"Removing the A8 Power Supply Assembly" on page 78.
remove the fuse holder, fan, or power supply cables...	"Disconnecting Subassembly Power Connectors" on page 79.
remove the front panel...	"Removing the Front Panel" on page 80.
remove the back panel...	"Removing the Back Panel" on page 82.
remove the A4 assembly ^a ...	"Removing the A4 Assembly" on page 84.
remove the A9 assembly ^a ...	"Removing the A9 Assembly" on page 86.
remove the A4 and A9 assemblies as a unit...	"Removing the A4 and A9 Assemblies as a Unit" on page 89.
remove the A10 assembly or semi-rigid cables...	"Removing the A10 Assembly and Semi-Rigid Cables" on page 91
remove the A11 assembly...	"Removing the A11 Assembly" on page 93
remove the A2 or A5 assembly...	"Removing the A2 and A5 Assemblies" on page 94.
remove the A3 motherboard...	"Removing the A3 Assembly" on page 97.

- a. To remove the A4 and A9 assemblies as one unit, see ["Removing the A4 and A9 Assemblies as a Unit" on page 89.](#)

Separating Units and Removing Cover

To separate the Cellular Adapter from the Test Set and to remove the adapter's cover:

1. Disconnect all power and interconnecting cables from the Cellular Adapter.
2. Separate the Cellular Adapter from the Test Set after removing the 7 screws that secure the units together, see figure 15:
 - 4 screws from the side brackets
 - 3 screws from the back mounting plate

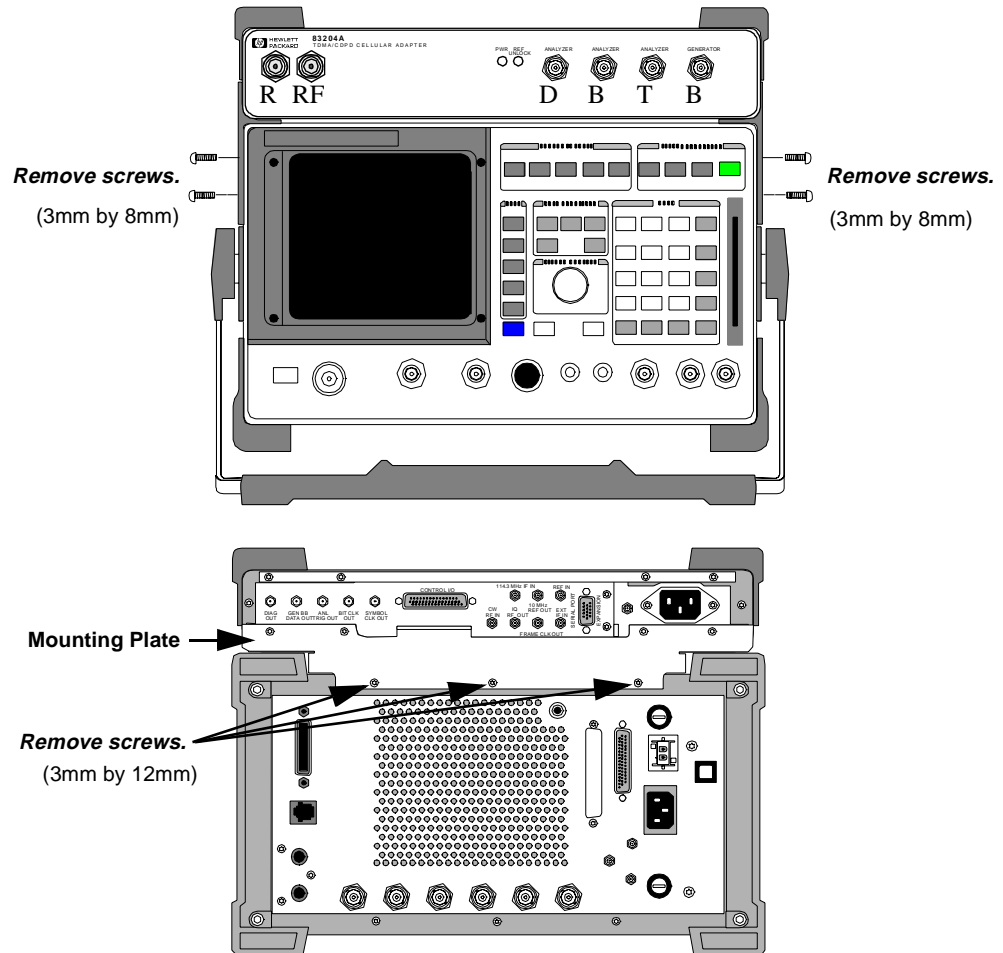

Figure 15

Removing the Cellular Adapter's Mounting Screws

3. Remove the cross bar and mounting plate from the Cellular Adapter by removing the screws shown in **figure 16**.
4. Slide the cover from the Cellular Adapter's deck, see figure 17.

This concludes the procedure for removing the cover from the Cellular Adapter.

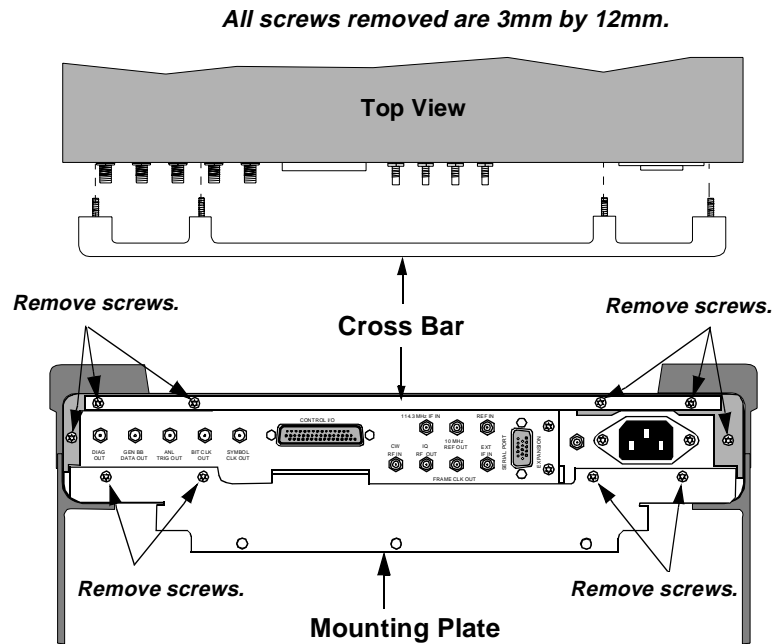

Figure 16 Removing the Cross Bar and Mounting Plate

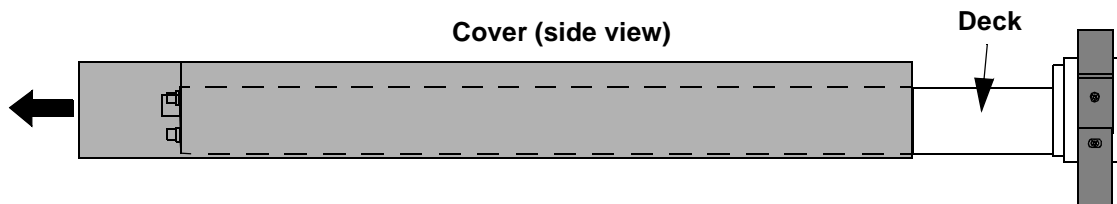
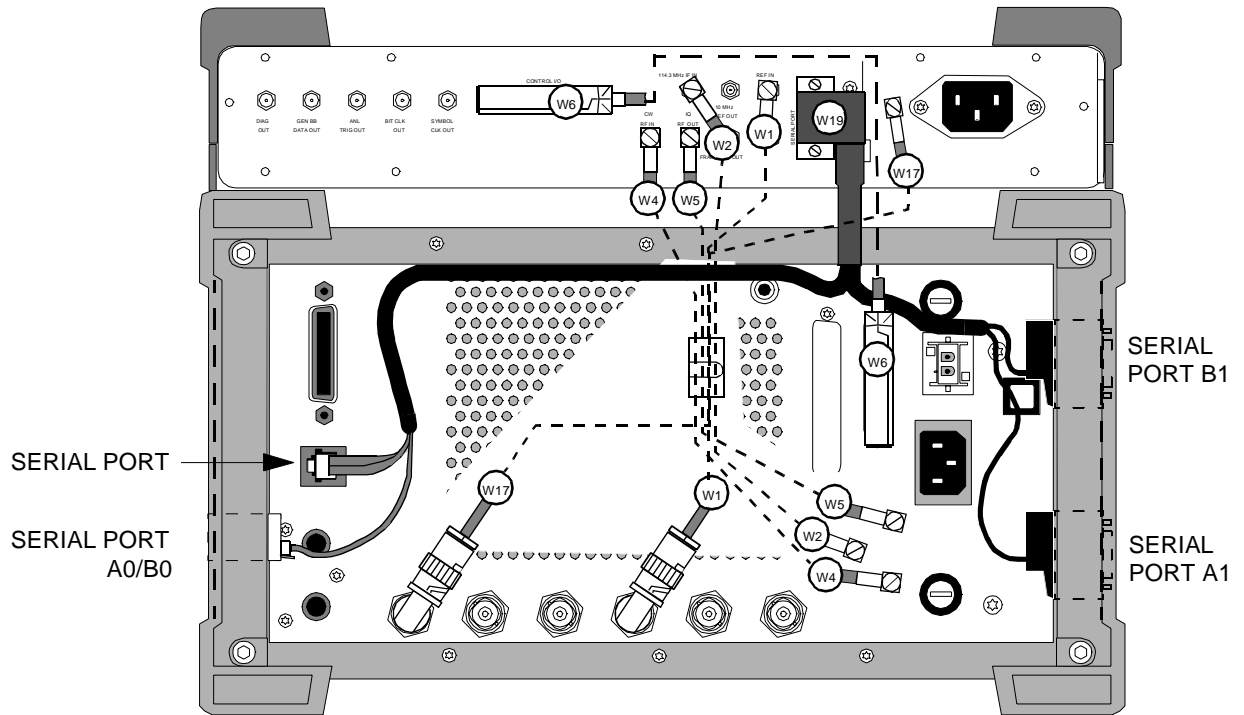

Figure 17 Removing the Cover

Operation Without Cover

To operate the Cellular Adapter without its cover, place the Cellular Adapter on the Test Set without installing the screws that secure it to the Test Set, and then reconnect the cables as shown in **figure 18**.



HP 8921A Test Set	Wire No.	HP 83204A TDMA/CDPD Cellular Adapter
		10 MHz REF OUT
	W1	REF IN
		114.3 MHz IF OUT
	W2	114.3 MHz IF IN
		CW RF OUT
	W4	CW RF IN

* Options 002 & 003 only

Figure 18

Back Panel Cable Connections for HP 83204A TDMA/CDPD Cellular Adapter

Removing the A8 Power Supply Assembly

To remove the A8 power supply assembly:

1. Disconnect the power connector from the A8 power assembly, see [figure 19](#) .
2. Disconnect the primary cable from the A8 assembly.
3. Remove 4 screws and lift the A8 assembly from the deck.

This concludes the procedure for removal of the A8 power supply assembly.

All screws removed are 3mm by 8mm.

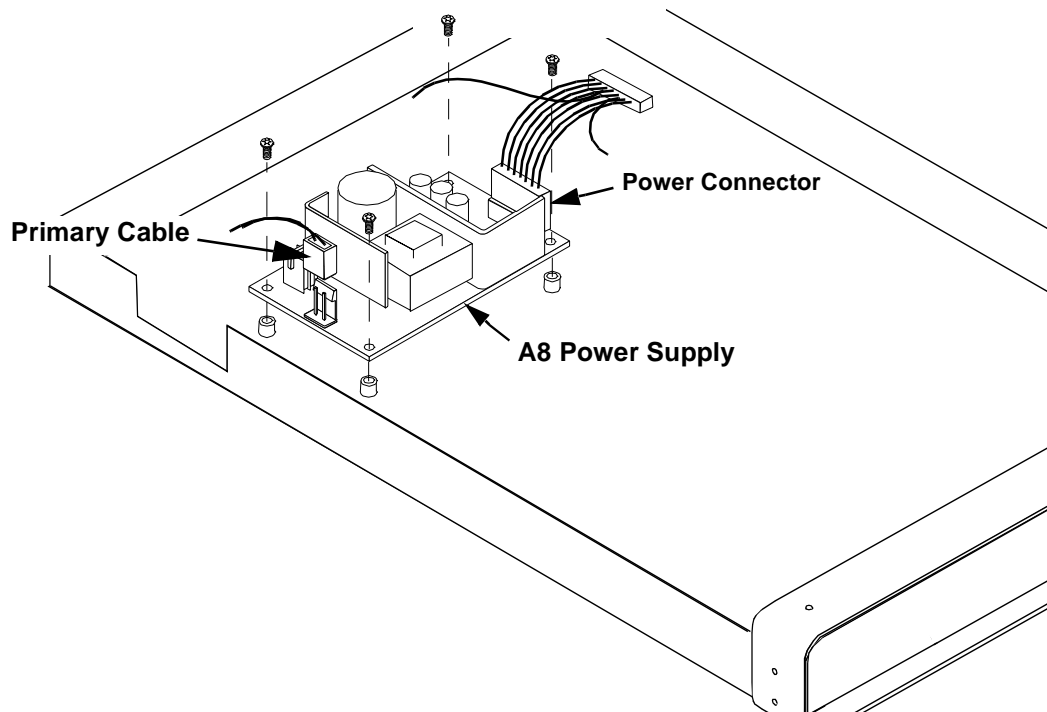

Figure 19

Removing the A8 Power Supply Assembly

Disconnecting Subassembly Power Connectors

Disconnect the connectors shown in [Table 5](#) and [figure 20](#) if you need to replace the fan, fuse holder, A8 power supply assembly, or A3 motherboard assembly.

Table 5 Subassembly Connections

If replacing...	Disconnect connector...
Fan	(A4 assembly) J20
Fuse holder	(A3 assembly) J7
Power supply assembly	Primary and Output Power connectors (Also see " Removing the A8 Power Supply Assembly " on page 78.)
A3 motherboard	(A3 assembly) J1 and J7 connectors

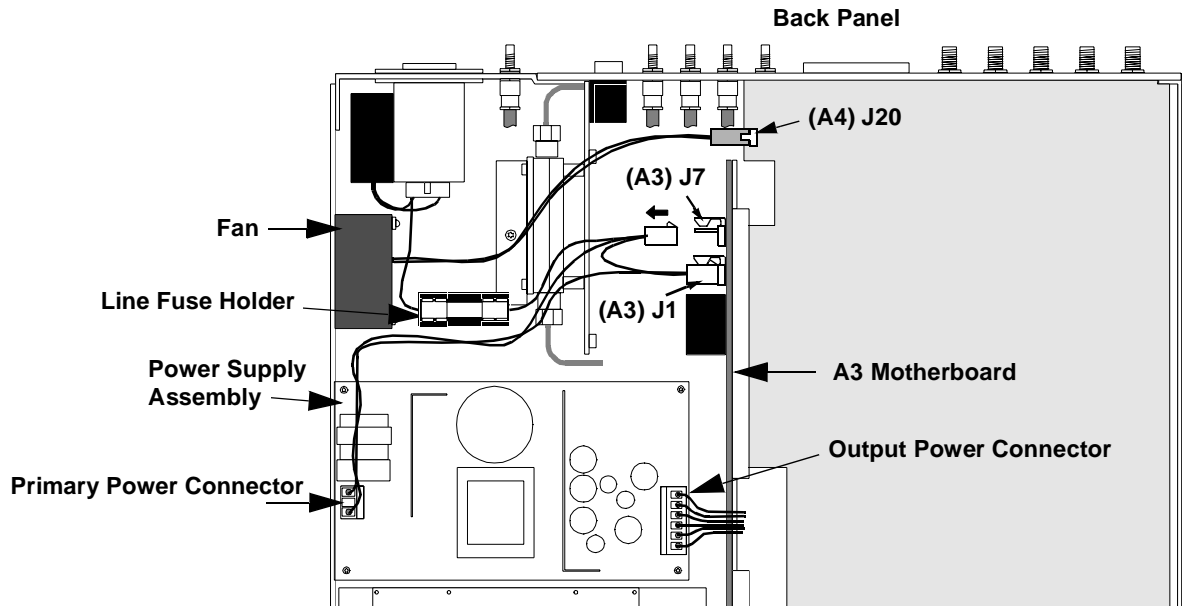

Figure 20 Removing the Power Connectors

Removing the Front Panel

In order to access or remove the A2, A5, or A11 assemblies, or the A4/A9 assembly, it is necessary to remove the front panel of the Cellular Adapter.

1. Remove the Cellular Adapter's cover. See "[Separating Units and Removing Cover](#)" on page 75.
2. Remove the 2 bumpers and 2 brackets from the front frame as shown in [figure 21](#).
3. Remove the 5 frame screws and the two 3/4-inch nuts shown in [figure 22](#).

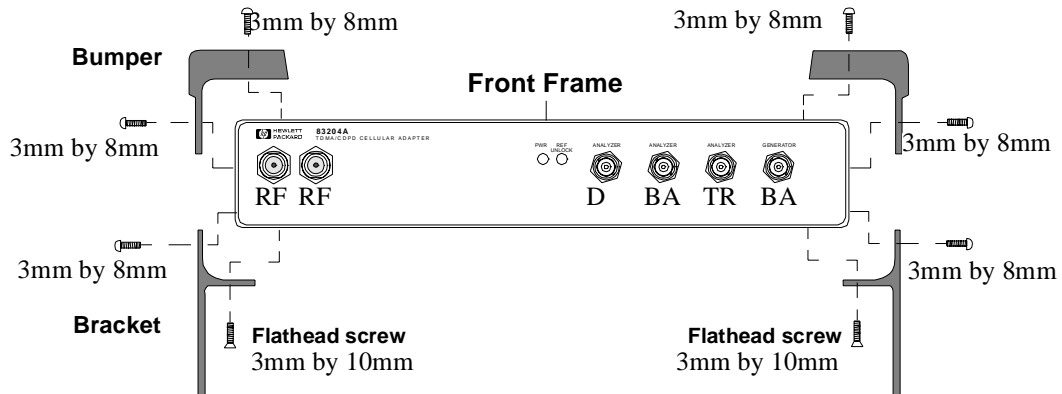

Figure 21 Removing the Bumpers and Brackets

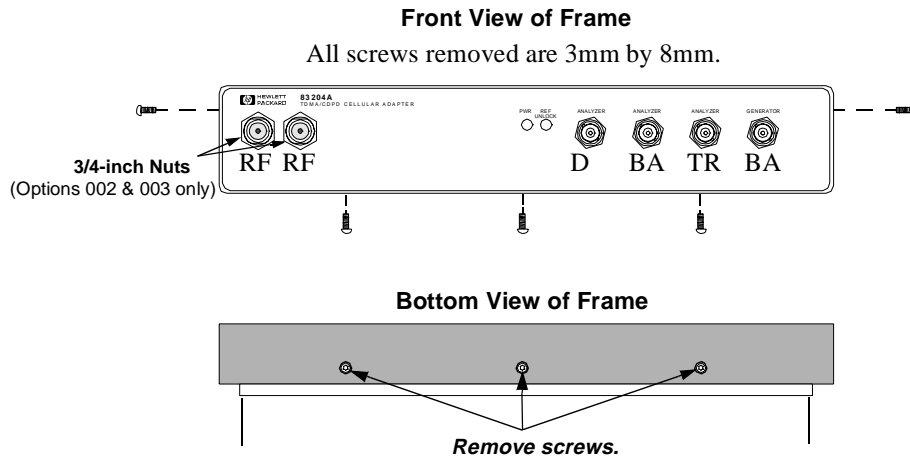

Figure 22 Removing the Frame Screws

4. Pull the frame away from the deck and disconnect the coaxial cables from the A4 assembly, see [figure 23](#) . If necessary use a small flat-blade screwdriver to disconnect the connectors.

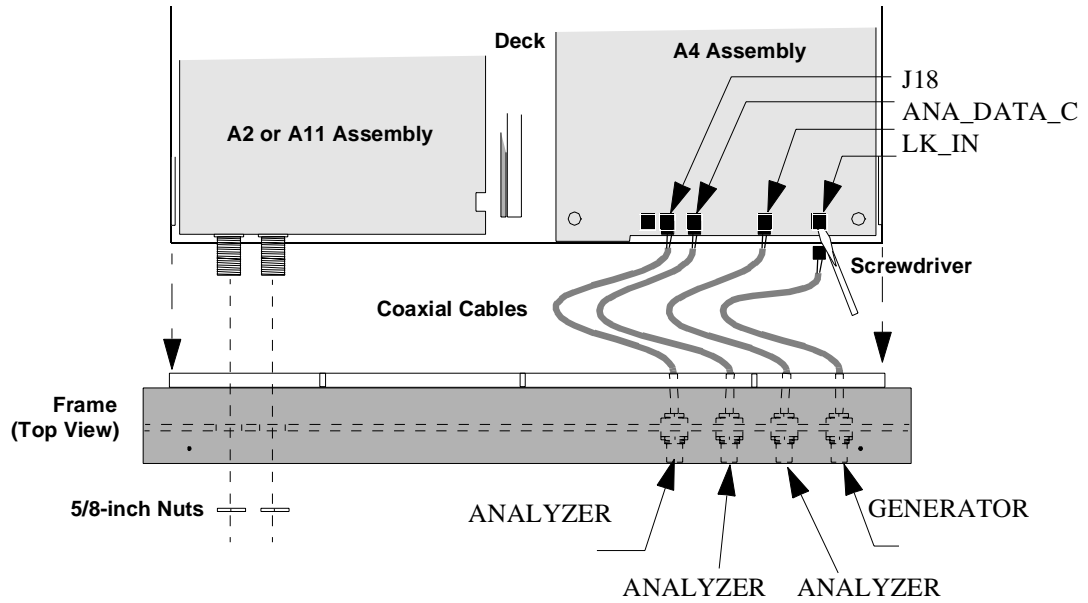

Figure 23 Disconnecting the Coaxial Cables from the A4 Assembly

This completes the procedure for removing the front panel. When reassembling the front panel frame, use [Table 6](#) below and [figure 23](#) above to reconnect the cables of the front panel to the A4 assembly.

Table 6 Front Panel and A4 Assembly Connections

Connector/Cable of Front Panel	goes to A4 connector...
ANALYZER - DATA CLOCK IN	J18 (ANA_DATA_CLK_IN)
ANALYZER - BASEBAND DATA IN	J7 (ANA_BB_DATA_IN)
ANALYZER - TRIGGER IN	J5 (ANA_TRIG_IN)
GENERATOR - BASEBAND DATA IN	J14 (GEN_BB_DATA_IN)

NOTE: When replacing front cover, be careful not to crimp or pinch the front panel cables.

Removing the Back Panel

In order to remove the A4 assembly and/or A9 assembly of the Cellular Adapter, it is necessary to remove the the back panel. Needed for this procedure is a 3/16-, 1/4-, and 5/16-inch wrench or nut driver.

1. Remove the Cellular Adapter's cover. See "[Separating Units and Removing Cover](#)" on page 75.
2. Remove the 3/16-inch connector locks and two 3mm by 12mm screws shown in [figure 24](#) and [figure 25](#) .
3. With a 5/16-inch wrench or nut driver remove five SMA nuts and lock washers and pull the back panel away from the deck as shown in [figure 25](#) .

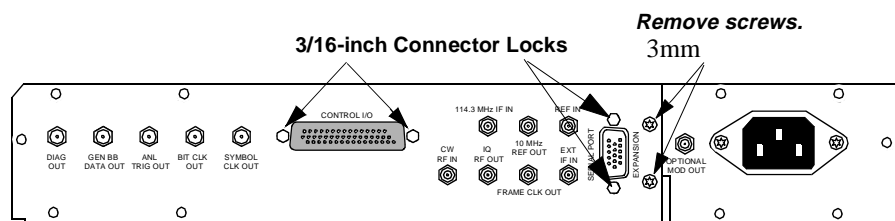

Figure 24 Removing the Back Panel Connector Locks and Screws

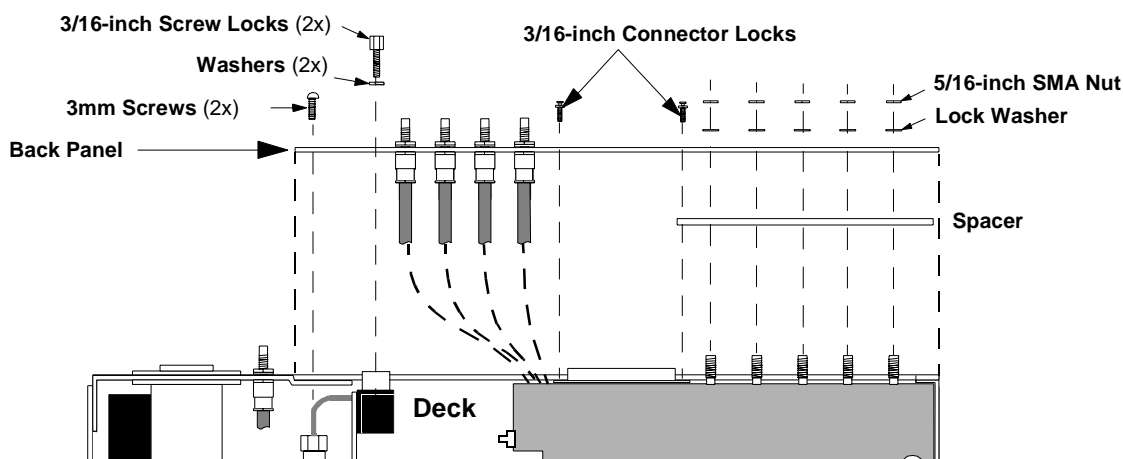

Figure 25 Removing the Back Panel

- Access to other assemblies on the deck is now possible without removing the SMC connectors (shown in [figure 26](#)) from the back panel. If complete removal of the back panel is necessary, use a 1/4-inch wrench or deep nut-driver to disconnect the SMC connectors from the back panel.

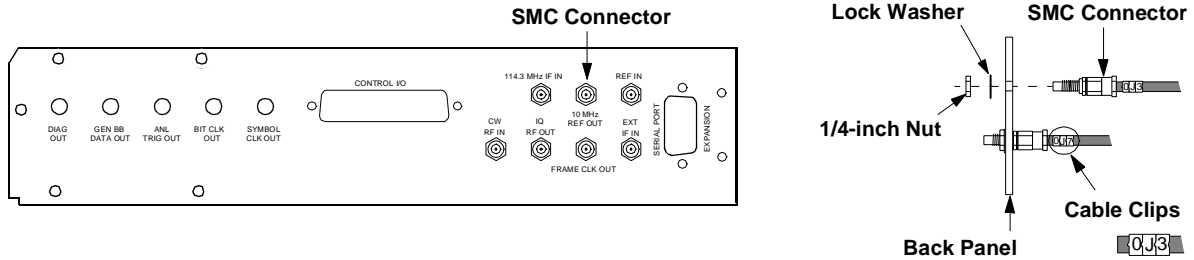

Figure 26 Back Panel SMC Connector Removal

This completes the procedure for the removal of the rear panel.

Cable clips identify the location of each SMC connector on the back panel (see [figure 26](#)). If the connectors are removed from the back panel, use [Table 7](#) below to identify the location of the connectors when reinstalling the panel.

Table 7 Back Panel Connector Locations

Back Panel Label	Cable Clip Number
114.3 MHz IF IN	OJ1
10 MHz REF OUT	OJ2
REF IN	OJ3
CW RF IN	OJ4
IQ RF OUT	OJ5
FRAME CLK OUT	OJ6
EXT IF IN	OJ7

Removing the A4 Assembly

The following instructions tell how to remove the A4 Premod Filter assembly from the Cellular Adapter's deck. An alternative to using the following procedure is to remove the A4 and A9 assemblies as a unit, see "[Removing the A4 and A9 Assemblies as a Unit](#)" on page 89.

NOTE

Perform a periodic calibration, PER_CALD, after replacing the A4 assembly (see "[Periodic Self Calibration](#)," in [chapter 7](#), on page 149).

To remove the A4 assembly:

1. Remove the cover from the Cellular Adapter. See "[Separating Units and Removing Cover](#)" on page 75.
2. Remove the Cellular Adapter's front panel, see "[Removing the Front Panel](#)" on page 80.
3. Remove the back panel, see "[Removing the Back Panel](#)" on page 82.
4. Remove the seven screws that secure the A4 assembly to the A9 assembly, see [figure 27 on page 85](#).
5. Disconnect the following connectors from the A4 assembly: fan cable at J20, power cable at J9, W16 ribbon cable at J10, and W22 cable at J24 (Options 002 & 003 only).
6. Carefully unplug the A4 assembly from the A3 motherboard's J2 connector. You will have to lift the opposite side of the A4 assembly over the edge of the deck to unplug it.
7. Disconnect the SMB coaxial cables from the A4 assembly and lift the A4 assembly. Cable clips identify each SMB connector.

This completes the procedure for the removal of the A4 assembly. Use [figure 27 on page 85](#) to identify the location of the connectors and cables when reinstalling the A4 assembly.

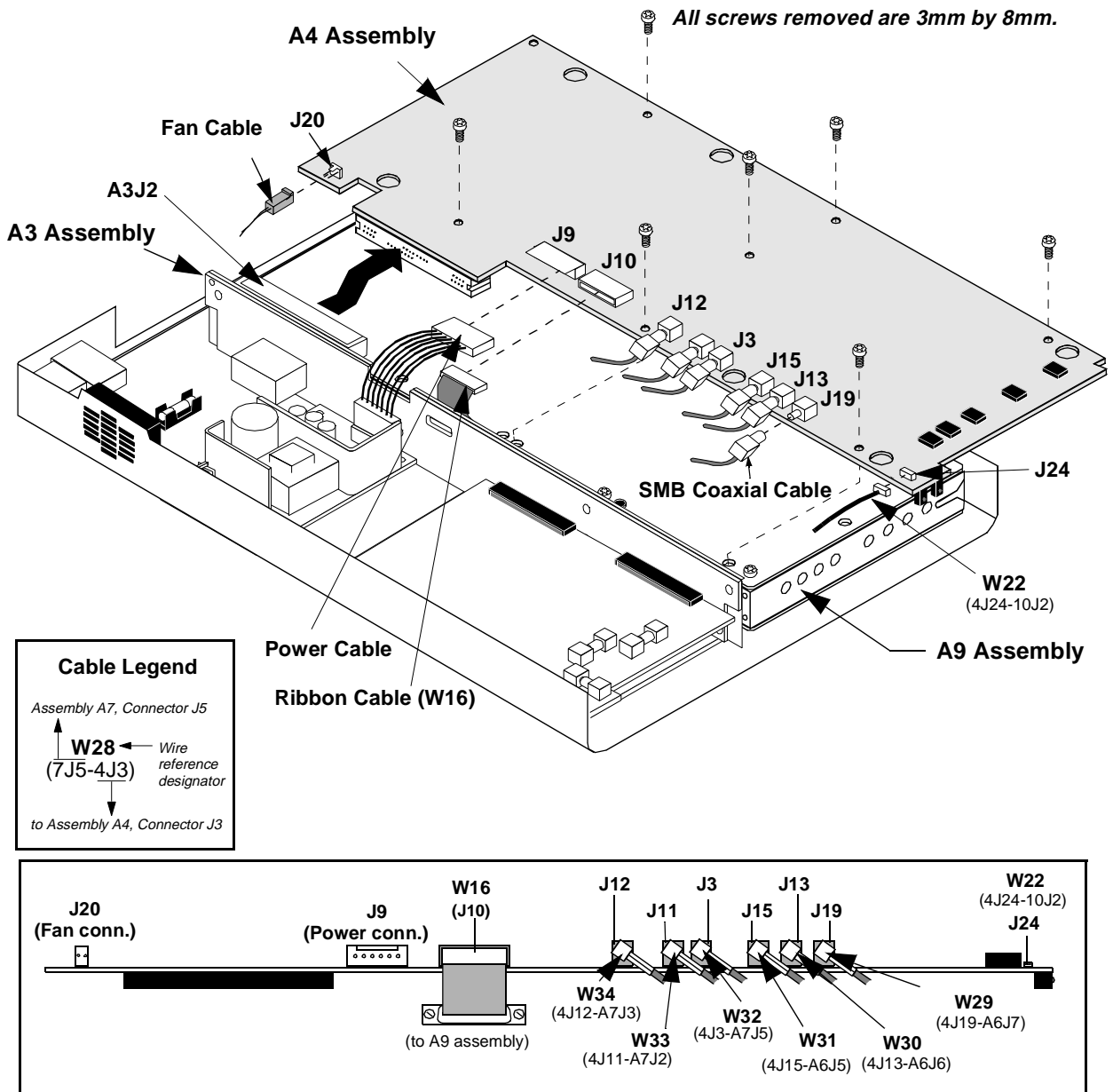

Figure 27 Removing the A4 Assembly

Removing the A9 Assembly

The following instructions remove the A9 Ref/IQ Modulator assembly unit from the Cellular Adapter's deck. An alternative to this procedure is to remove the A4 assembly and A9 assembly as a unit, see ["Removing the A4 and A9 Assemblies as a Unit" on page 89](#).

NOTE

Perform a periodic calibration, PER_CALD, after replacing the A9 assembly (see ["Periodic Self Calibration" on page 149](#)).

1. Remove the cover from the Cellular Adapter. See ["Separating Units and Removing Cover" on page 75](#).
2. Remove the front panel. See ["Removing the Front Panel" on page 80](#).
3. Remove the back panel. See ["Removing the Back Panel" on page 82](#).
4. Remove the A4 RF/GEN assembly. See ["Removing the A4 Assembly" on page 84](#).
5. Remove the 6 screws that secure the A9 assembly to the deck, see [figure 28](#). The A9 assembly can now be lifted from the deck.
6. Disconnect all the SMB connectors from the A9 assembly, see [figure 28](#). (SMB cables are identified with cables clips designating the reference number of the assembly and connector's reference number on the assembly, for example, 7J5 = A7 assembly, connector J5)
7. With a small flat blade screwdriver, remove the ribbon connector from the A9 assembly.

This completes the procedure for the removal and disassembly of the A9 assembly. When reassembling the A9 assembly, use [figure 28 on page 87](#) and [table 8 on page 88](#) to help you determine the location of the SMB connector/coaxial cables.

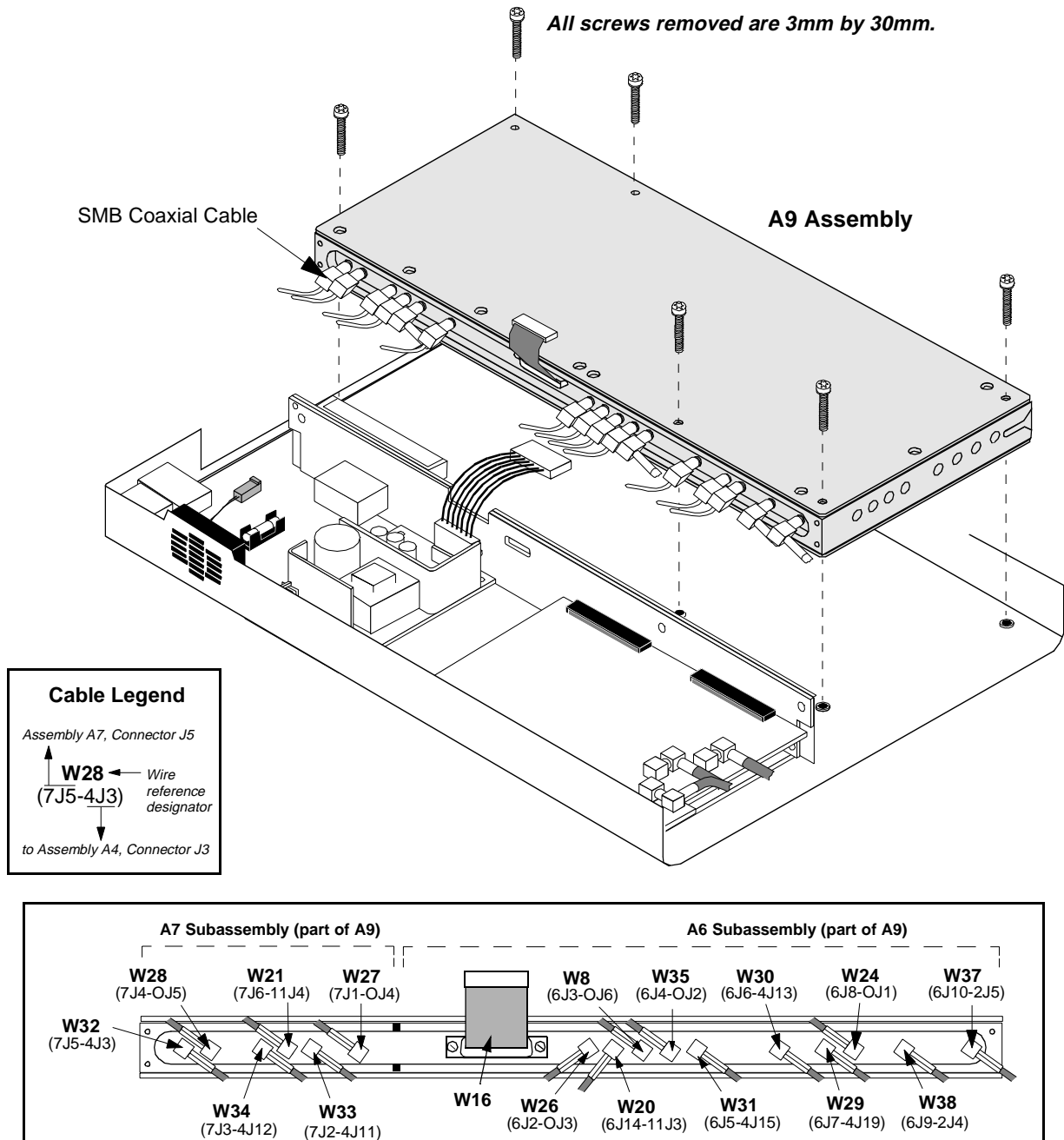

Figure 28 Removing the A9 Assembly

Table 8 A9 Assembly Cable Connections

A9 Assembly Cable End		Other end of cable goes to..	
Cable Clip # (Connector Type)	Connector	Cable Clip # (Connector Type)	Destination
6J14(SMB)	A9/A6 subassembly, J14 connector	11J3 (SMB)	A11 assembly, J3 connector
6J10 (SMB)	A9/A6 subassembly, J10 connector	2J5 (SMB)	A2 assembly, J5 connector
6J9 (SMB)	A9/A6 subassembly, J9 connector	2J4 (SMB)	A2 assembly, J4 connector
6J8 (SMB)	A9/A6 subassembly, J8 connector	OJ1 (SMC)	OJ1 connector on back panel - 114.3 MHz IF IN
6J7 (SMB)	A9/A6 subassembly, J7 connector	4J19 (SMB)	A4 assembly, J19 connector
6J6 (SMB)	A9/A6 subassembly, J6 connector	4J13 (SMB)	A4 assembly, J13 connector
6J5 (SMB)	A9/A6 subassembly, J5 connector	4J15 (SMB)	A4 assembly, J15 connector
6J4 (SMB)	A9/A6 subassembly, J4 connector	OJ2 (SMC)	OJ2 connector on back panel - 10 MHz REF OUT
6J3 (SMB)	A9/A6 subassembly, J3 connector	OJ6 (SMC)	OJ6 connector on back panel - FRAME CLK OUT
6J2 (SMB)	A9/A6 subassembly, J2 connector	OJ3 (SMB)	OJ3 connector on back panel - RF IN
N/A (W16 Ribbon Cable Connector)	A9/A6 subassembly, J1 connector	N/A (W16 Ribbon Cable Connector)	A4 assembly, J10 connector
7J1 (SMB)	A9/A7 subassembly, J1 connector	OJ4 (SMC)	OJ4 connector on back panel - CW REF IN
7J2 (SMB)	A9/A7 subassembly, J2 connector	4J11 (SMB)	A4 assembly, J11 connector
7J3 (SMB)	A9/A7 subassembly, J3 connector	4J12 (SMB)	A4 assembly, J12 connector
7J4 (SMB)	A9/A7 subassembly, J4 connector	OJ5 (SMC)	OJ5 connector on back panel - IQ RF OUT
7J5 (SMB)	A9/A7 subassembly, J5 connector	4J3 (SMB)	A4 assembly, J3 connector
7J6 (SMB)	A9/A7 subassembly, J6 connector	11J4 (SMB)	A11 assembly, J4 connector

Removing the A4 and A9 Assemblies as a Unit

To remove the A4 and A9 assemblies as a unit from the Cellular Adapter's deck:

NOTE

Perform a periodic calibration, PER_CALD, after replacing the A4/A9 assembly (see ["Periodic Self Calibration" on page 149](#)).

1. Remove the cover from the Cellular Adapter, see ["Separating Units and Removing Cover" on page 75](#).
2. Remove the front panel. See ["Removing the Front Panel" on page 80](#).
3. Remove the back panel. See ["Removing the Back Panel" on page 82](#).
4. Disconnect the connectors on the A4 and A9 assemblies, see [figure 29 on page 90](#).
5. Remove the A11 assembly (on Options 002 & 003), see ["Removing the A11 Assembly" on page 93](#).
6. Disconnect the 2J3, 2J4, and 2J6 SMB connectors from the A2 assembly, see [figure 29 on page 90](#).
7. Remove the 6 screws that secure the A4/A9 assembly to the deck, see [figure 29](#).
8. Carefully lift the A4/A9 assembly over the edge of the deck to disconnect the A4 assembly's J6 connector from the A3 motherboard.

This completes the procedure for the removal of the A4/A9 assembly unit. To reinstall the A4/A9 assembly, see ["Reinstalling the A4/A9 Assembly"](#).

Reinstalling the A4/A9 Assembly

To reinstall the A4/A9 assembly, reverse the steps of the previous section.

1. Use [figure 29](#) to help you determine the location of the SMB coaxial connectors. The ends of the coaxial cables are identified with cable clips. For more detail of the A4 assembly SMB connectors, see [figure 27 on page 85](#). For details of the A9 assembly see [figure 28 on page 87](#) and [table 8 on page 88](#).
2. Carefully plug the A4/A9 assembly into the A3 motherboard. Ensure that the assembly is squarely plugged in and be sure not to get a cable caught under the A4/A9 assembly or you will have difficulty trying to fasten down the assembly.
3. Secure the assembly with the six screws (3mm by 30mm) previously removed.
4. Reconnect the 2J3, 2J4, and 2J6 SMB connectors to the A2 assembly.
5. Reconnect the J9 connector on the A4 assembly.
6. Reinstall the back and front panels.

This concludes the procedure for reassembly of the Cellular Adapter.

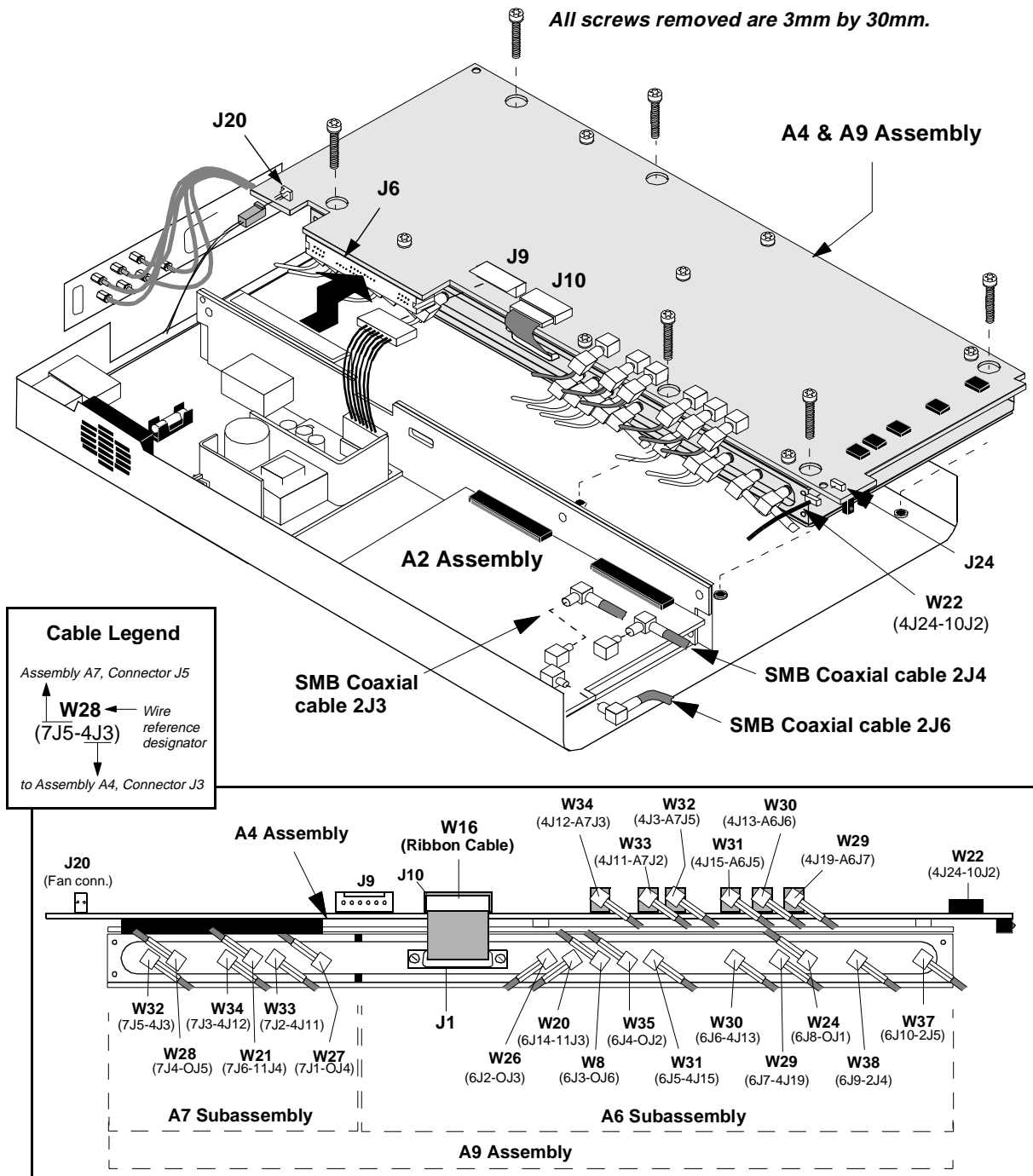

Figure 29 Removing the A4/A9 Assembly

Removing the A10 Assembly and Semi-Rigid Cables

To remove the A10 assembly and semi-rigid cables:

1. Remove the cover from the Cellular Adapter, see ["Separating Units and Removing Cover" on page 75](#).
2. Remove the front panel, see ["Removing the Front Panel" on page 80](#).
3. Remove the back panel, see ["Removing the Back Panel" on page 82](#).
4. Remove the A4/A9 assembly, see ["Removing the A4 and A9 Assemblies as a Unit" on page 89](#).
5. Remove the cable connectors on the A10 assembly:
 - If you are replacing the semi-rigid cables W10 and W11, disconnect the W10 and W11 connectors on the A10 assembly, see figure 30.
 - If you are replacing the A10 assembly, disconnect the W10, W11, W14 connectors and the connectors at J1, J2, J3, and J4 on the A10 assembly, see figure 30.
6. To remove the semi-rigid cables, remove the cable clamps securing W10 and W11 semi-rigid cables to the chassis, see figure 31 on page 92.
7. To remove the A10 assembly, remove the screw securing the A10 assembly to the deck, see figure 31 on page 92.

This completes the procedure for removal of semi-rigid cables and the A10 assembly.

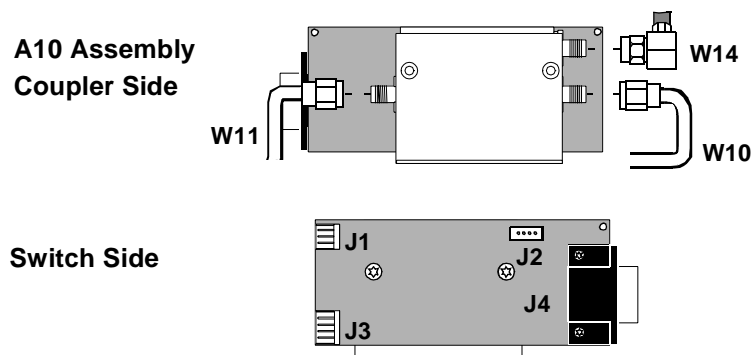

Figure 30 A10 Assembly (Directional Coupler)

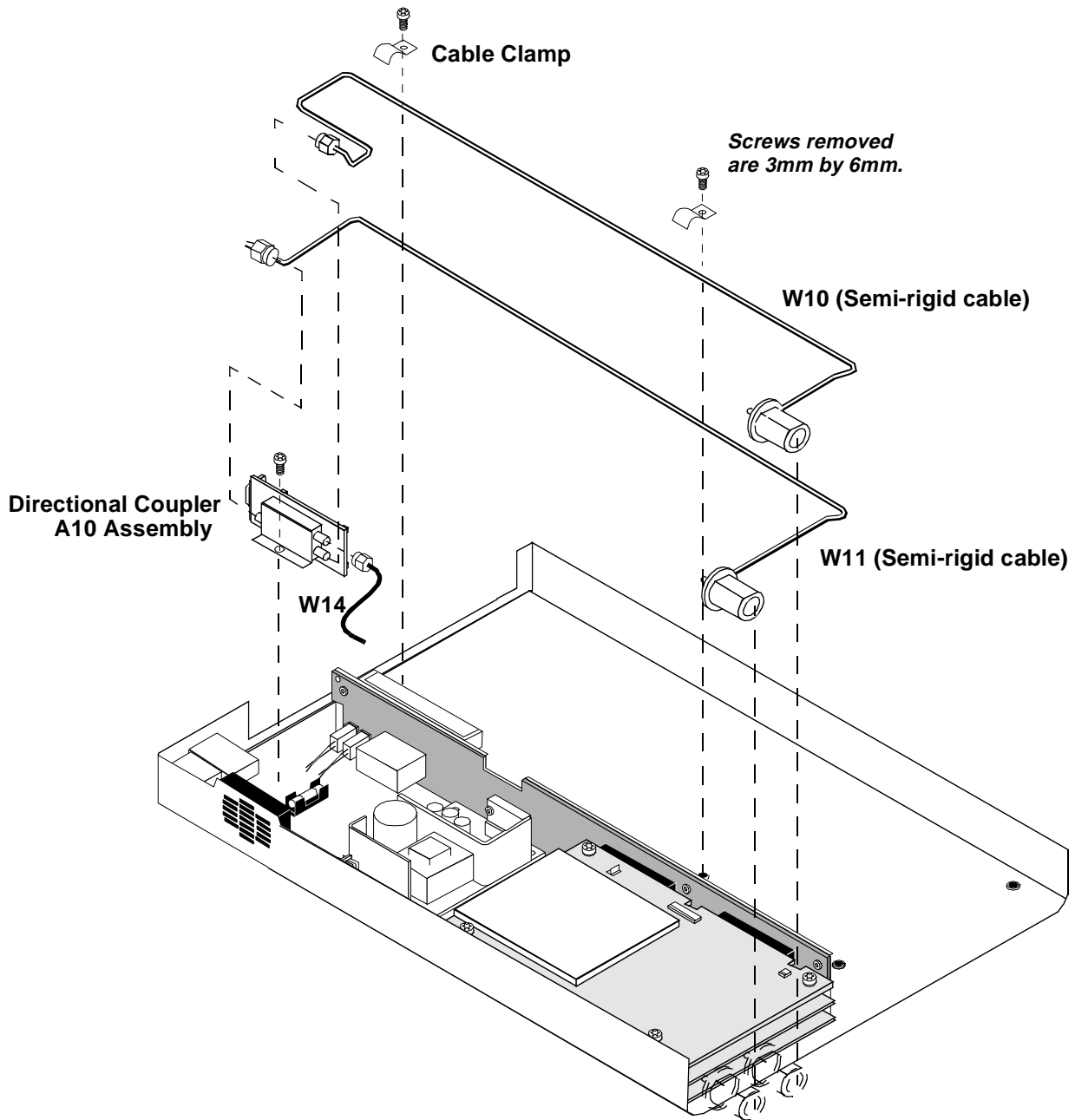

Figure 31 Removing the A10 Assembly & Semi-rigid Cables

Removing the A11 Assembly

To remove the A11 CDPD assembly:

1. Remove the cover from the Cellular Adapter, see "Separating Units and Removing Cover" on page 75.
2. Remove the front panel, see "Removing the Front Panel" on page 80.
3. Remove the four machine screws securing the A11 assembly, see figure 32.
4. Disconnect wires A8W1, W12, W13, W14, W15, W20, W21 from the A11 assembly.

Carefully lift the A11 assembly over the edge of the Cellular Adapter and pull it away from the motherboard. This completes the procedure for the removal of the A11 assembly.

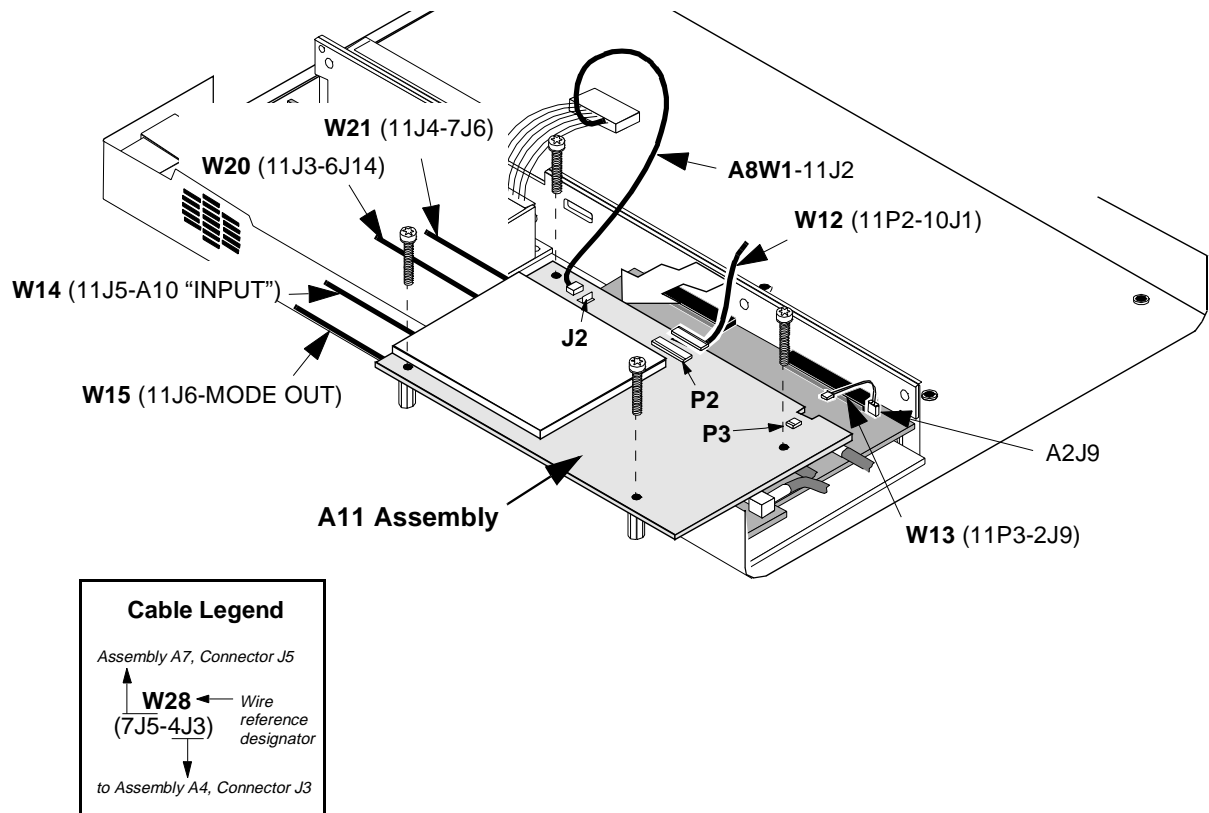

Figure 32 Removing the A11 Assembly

Removing the A2 and A5 Assemblies

To remove the A2 RCV DSP or A5 Data Buffer assembly:

1. Remove the cover from the Cellular Adapter. See ["Separating Units and Removing Cover" on page 75](#).
2. Remove the front panel of the Cellular Adapter Cellular Adapter. See ["Removing the Front Panel" on page 80](#).
3. If the Cellular Adapter is an Option 001, go to step 4, otherwise remove the A11 assembly, see ["Removing the A11 Assembly" on page 93](#).
4. Disconnect the SMB connectors 2J3, 2J4, and 2J6 from the A2 assembly, see [figure 33](#).

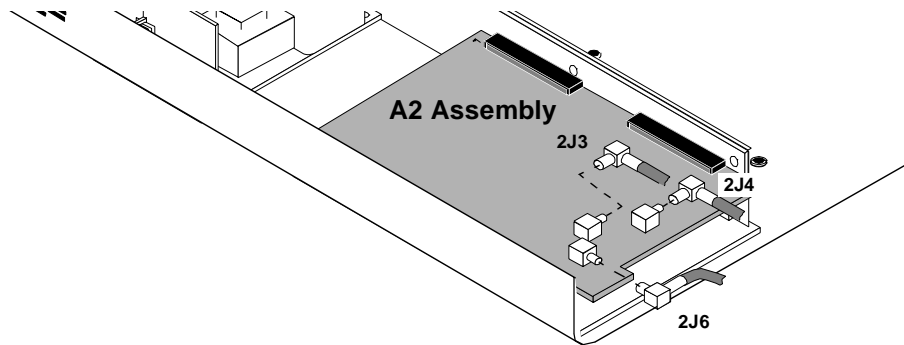

Figure 33 Removing A2 Assembly SMB Connectors

5. If the Cellular Adapter is an Option 002 or Option 003, go to step 6. For Option 001, remove the 2 screws securing the A2 (and A5) assembly to the deck, see [figure 34](#). There are 2 spacers attached under the A2 assembly.

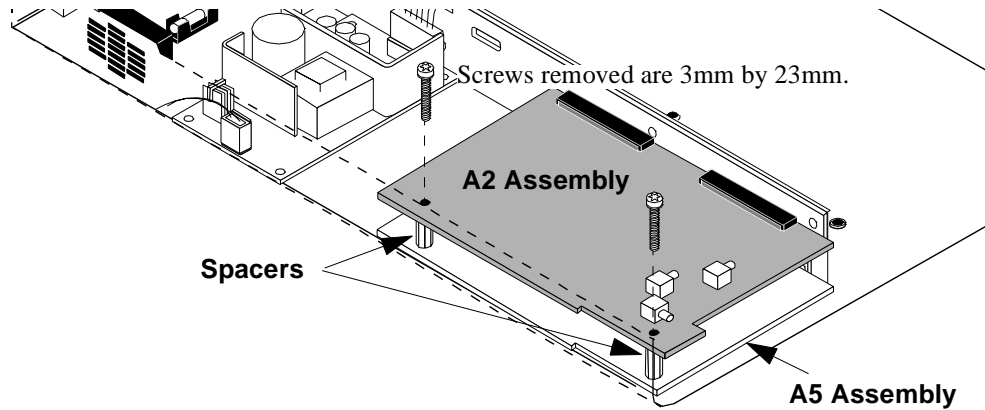

Figure 34 Removing A2 Assembly Screws

6. With a flat blade screwdriver wedged between the A2 assembly and the A3 assembly, carefully push and tilt the end of the A2 assembly over the edge of the deck to unplug it from the J3 and J4 connectors, see [figure 35](#) .
7. If the Cellular Adapter is an Option 001 or 003, using a flat-blade screwdriver, carefully tilt the end of the A5 assembly over the edge of the deck and unplug it from the J5 and J6 connectors of the A3 assembly, see [figure 36](#) .

This completes the procedure for the removal of the A2 and A5 assemblies. To reassemble the Cellular Adapter, perform the previous steps in reverse order.

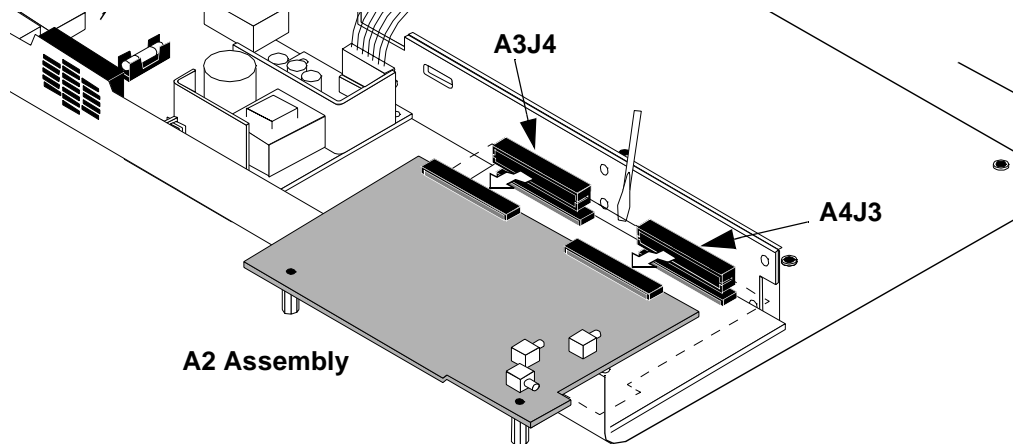

Figure 35 Removing the A2 Assembly

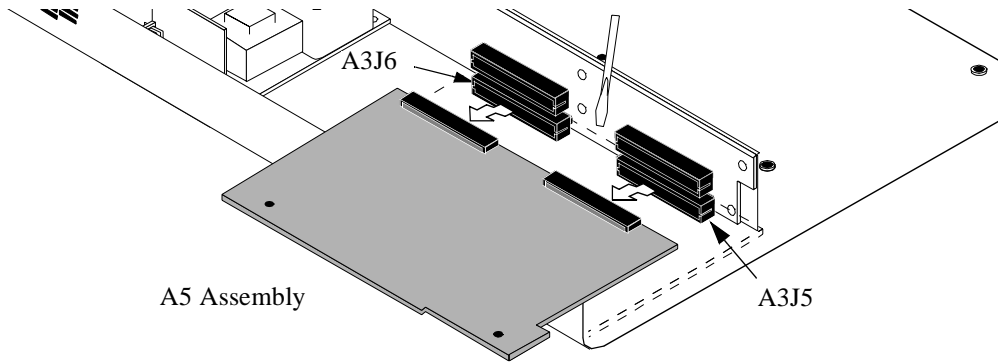

Figure 36 **Removing the A5 Assembly**

Removing the A3 Assembly

To remove the A3 motherboard assembly:

1. Remove the cover from the Cellular Adapter. See ["Separating Units and Removing Cover" on page 75](#).
2. Remove the front panel, see ["Removing the Front Panel" on page 80](#).
3. Remove the back panel, see ["Removing the Back Panel" on page 82](#).
4. Remove the A4 assembly, see ["Removing the A4 Assembly" on page 84](#).
5. Remove the A9 assembly, see ["Removing the A9 Assembly" on page 86](#).
6. If the Cellular Adapter is an Option 002 or 003, remove the A11 assembly, see ["Removing the A11 Assembly" on page 93](#).
7. Remove the A2 and A5 assemblies, see ["Removing the A2 and A5 Assemblies" on page 94](#).
8. Remove the power connectors from the J7 and J1 connectors on the A3 assembly, see [figure 37](#).
9. If the Cellular Adapter is an Option 001, remove the 4 screws securing the A3 assembly to the deck, see [figure 37](#). If the Cellular Adapter is an Option 002 or 003, two of the screws secure the CDPD semi-rigid cables to the deck, see [figure 31 on page 92](#).

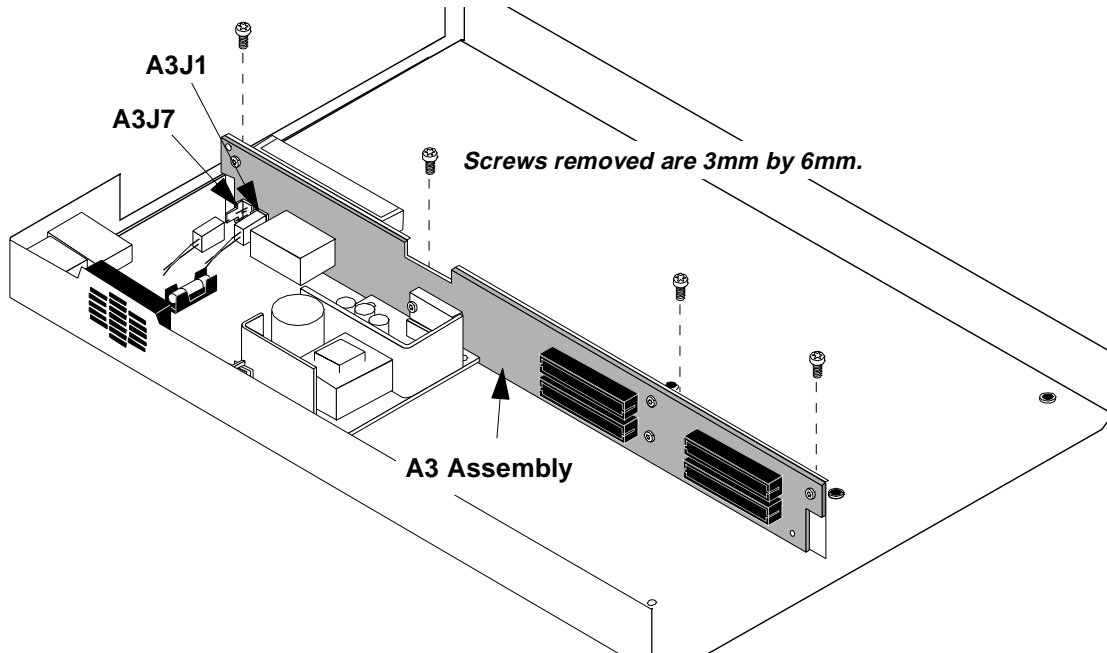

Figure 37 Removing the A3 Assembly

This completes the procedure for the removal of the A3 assembly. To reassemble the Cellular Adapter, follow the previous steps in reverse order.

Modifications

This chapter explains how to load and verify firmware upgrades on the HP 83204A Cellular Adapter.

Firmware Upgrades

Firmware in the HP 83204A Cellular Adapter and its companion HP 8921A Cell Site Test Set should be upgraded to the latest revision any time a repair is made or a performance problem is discovered.

The Test Set's firmware is upgraded by installing new PROMs. The Cellular Adapter's firmware is upgraded by downloading the new firmware files from memory cards to the EEPROMs of the Cellular Adapter. **Table 9** lists the upgrade kits available. For ordering information, see "**Ordering Parts,**" in **chapter 1, on page 45.**

Table 9 **Firmware Upgrade Kits**

Kit	Description
83204-61802	HP 83204A Cellular Adapter firmware
HP 8921A R98	HP 8921A Test Set firmware
83204-61807	CDPD application software
HP 83204A R99	<i>All of the above.</i>

Firmware Loading and Verification Procedures

This section contains procedures for loading Cellular Adapter's firmware, and for verifying proper operation of the Test Set's and the Cellular Adapter's firmware. The Cellular Adapter's firmware comes on three memory cards. Use [table 10](#) to help you determine the procedure to use when upgrading the Cellular Adapter's firmware.

Table 10 **Firmware Upgrade Procedures**

HP 83204A Cellular Adapter	Procedure to Perform		
	"Loading RX DSP Firmware" on page 102	"Loading TX DSP Firmware" on page 103	"Loading CDPD Firmware" on page 104
Option 001 (TDMA)	Required	Required	
Option 002 (CDPD)	Required		Required
Option 003 (TDMA & CDPD)	Required	Required	Required

Loading RX DSP Firmware

Use the procedure for loading RX DSP firmware on all options (001, 002, & 003) of the Cellular Adapter. The Test Set and Cellular Adapter must be connected together.

1. Power up the Test Set.
2. Insert the memory card 83204-10002 into the Test Set.
3. Press the TESTS key.
4. Set the **Select Procedure Location:** field to Card.
5. Set the **Select Procedure Filename:** field to DLFIRM.
6. Press k1 (Run Test).
7. Verify that the revision date of the current RX DSP firmware is older than the new RX DSP firmware. The date in the form YYYYMMDD (Y=year, M=month, D=day). If the date is not older, press k5 (**Stop Tst**) to stop the upgrade.
8. Press k2 (**RX DSP**).
9. Install memory card 83204-10003 when prompted and press **Continue**.

When loading is complete, power off the Test Set.

Loading TX DSP Firmware

Use the following procedure for loading TX DSP firmware on Options 001 and 003 of the HP 83204A Cellular Adapter.

1. Power up the Test Set.
2. Insert memory card 83204-10002 into the Test Set.
3. Press the TESTS key.
4. Set the **Select Procedure Location:** field to Card.
5. Set the **Select Procedure Filename:** field to DLFIRM.
6. Press k1 (Run Test).
7. Verify that the revision date of the current TX DSP firmware is older than the new TX DSP firmware (YYYYMMDD format).
8. Press k4 (**TX DSP**).

When loading is complete, power off the Test Set.

Loading CDPD Firmware

Use the following procedure for loading CDPD firmware on Options 002 and 003 of the HP 83204A Cellular Adapter.

1. Power up the Test Set.
2. Insert the memory card 83204-10004 into the Test Set.
3. Press the TESTS key.
4. Set the **Select Procedure Location:** field to Card.
5. Set the **Select Procedure Filename:** field to FWUPLOAD.
6. Press k1(Run Test).
7. Verify that the revision date of the current CDPD firmware is older than the new CDPD firmware (YYYYMMDD format).
8. Press k2 (**Continue**).

When loading is complete, power off the Test Set.

Verifying Firmware Version

The following procedure checks the version of firmware in the Test Set and Cellular Adapter and checks the RX DSP (rx_dsp_revision) and TX DSP (tx_dsp_revision) version levels of the Cellular Adapter.

1. Power up the Test Set and Cellular Adapter.
2. The Test Set's firmware version level appears in the upper part of the RX TEST screen:
 - For HP 83204A Option 001 the version level must be A.16.00 or higher
 - For HP 83204A Option 002 or 003, the version level must be A.17.00 or higherTo order new firmware, [see "Ordering Parts," in chapter 1, on page 45.](#)
3. Press the blue SHIFT key, then the DUPLEX key. The CONFIGURE screen appears.
4. Select SERVICE under the **To Screen** menu. The SERVICE screen appears.
5. Select the **Latch** field.
6. Move the cursor to **rx_dsp_revision** under the **Choices:** menu and select it.
7. Read the RX DSP firmware version number in the **Value** field. The value is a date in the form YYYYMMDD (Y=year, M=month, D=day).
 - For HP 83204A Option 001 the date must be 19960129 or later
 - For HP 83204A Option 002 or 003, the date must be 19960520 or laterTo order new firmware, [see "Ordering Parts," in chapter 1, on page 45.](#)
8. Move the cursor to **tx_dsp_revision** under the **Choices:** menu and select it.
9. Read the TX DSP firmware version number in the **Value** field. The value is a date. The date must be 19960114 or later. If the date is earlier, order new firmware. To order new firmware, [see "Ordering Parts," in chapter 1, on page 45](#)

Use the preceding procedures in this section for upgrading firmware if necessary.

Block Diagrams

This chapter provides information for helping you understand the operation of the HP 83204A Cellular Adapter and its TDMA and CDPD options.

Instrument Description

The HP 83204A Cellular Adapter is an add-on-instrument for the HP 8921A Test Set. The Cellular Adapter is controlled by the Test Set's host processor through the Test Set's front-panel selections or HP-IB commands to the Test Set. The Cellular Adapter mounts on top of the Test Set.

Adding the TDMA Cellular Adapter, Options 001 and 003, to the Test Set creates a system for testing radios to the NADC (North American Dual-Mode Cellular) standard. Dual mode refers to including both the Advanced Mobile Phone System (AMPS) standard and the newer Time Division Multiple Access (TDMA) standard in one box. The TDMA standard uses digital compression to increase the number of channels over the older AMPS system.

The CDPD Cellular Adapters, Options 002 and 003, include Cellular Digital Packet Data (CDPD) digital signal generation and analysis. CDPD is a packet data system which overlays the existing AMPS voice system. CDPD is designed for small bursts of data, and is not efficient for large file transfer type applications. CDPD uses a separate base station (Mobile Data Base Station, MDDBS) and is integrated into the antenna system of a cell site. When there is no voice traffic on a designated AMPS voice channel, the MDDBS may transmit packet data to mobile end stations or fixed end stations. When AMPS voice traffic is assigned to that channel, the MDDBS must power down and reacquire communications on another designated CDPD channel if available.

TDMA Cellular Adapter

Options 001 and 003 of the HP 83204A Cellular Adapter contain TDMA digital signal processing hardware and firmware to test the transmitter and receiver portions of TDMA base stations.

The TDMA Cellular Adapter permits the selective addition of I/Q Modulation to the Test Set's RF output to accommodate the TDMA (Time Division Multiple Access) format. The TDMA Cellular Adapter provides a number of TDMA functions. These include I/Q demodulation and analysis capability, I/Q encoding and modulation, and timing generation and synchronization.

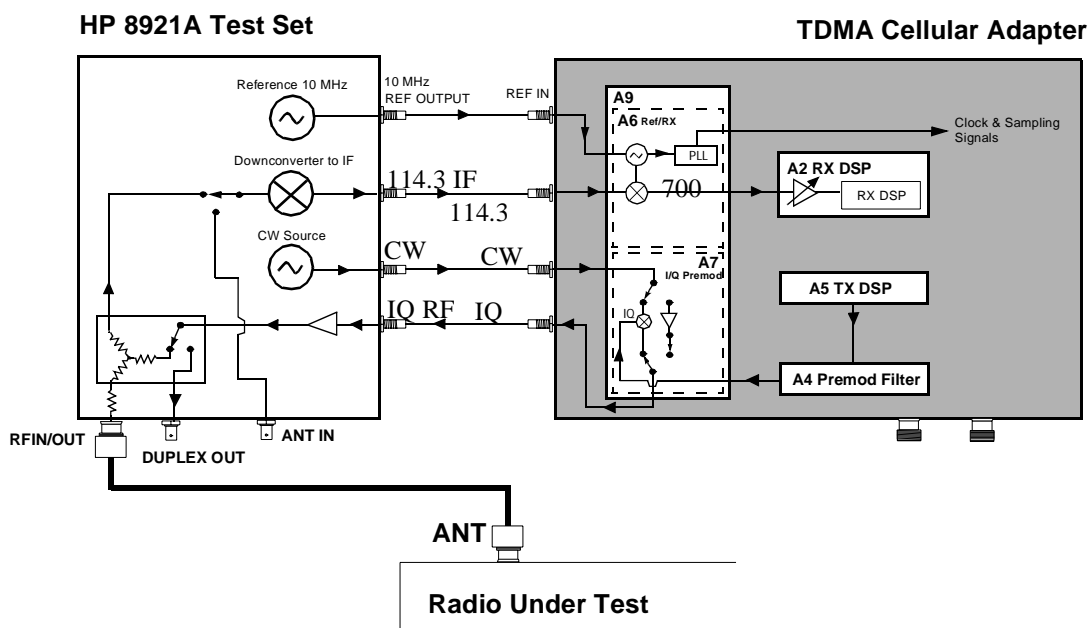

Figure 38

TDMA Test System Overview

TDMA Analysis

The analysis is accomplished by downconverting a 114.3 MHz IF signal from the Test Set to 700 kHz for processing by the Cellular Adapter's Receiver DSP board. See [figure 38](#) .

TDMA Generation

The Cellular Adapter generates data with the transmit DSP board, encodes the data using p/4 DQPSK, and then modulates the signal using the I/Q modulator before passing the signal to the Test Set. The Cellular Adapter will lock to several different time base reference frequencies. For instance, it can lock to the unit-under-test (for example, an NADC base station) or to the Test Set itself.

CDPD Cellular Adapter

Options 002 and 003 of the HP 83204A Cellular Adapter contain the hardware and firmware for testing CDPD mobile data base stations (MDBS).

CDPD Analysis

The Test Set down converts the CDPD signal to 114.3 MHz IF, see [figure 39](#). This 114.3 MHz IF is passed to the Cellular Adapter's receiver where it is converted to 700 MHz and passed to the RX DSP for analysis. The signal is checked for valid CDPD data using the A10 directional coupler and the DSP on the A11 CDPD assembly.

CDPD Generation

A CDPD data signal is generated by the DSP on the CDPD assembly, see [figure 39](#). It is then encoded with 0.5 GMSK before being passed to the Test Set for modulation. The signal is passed back to the Cellular Adapter's I/Q modulator for amplitude control before being amplified and transmitted by the Test Set.

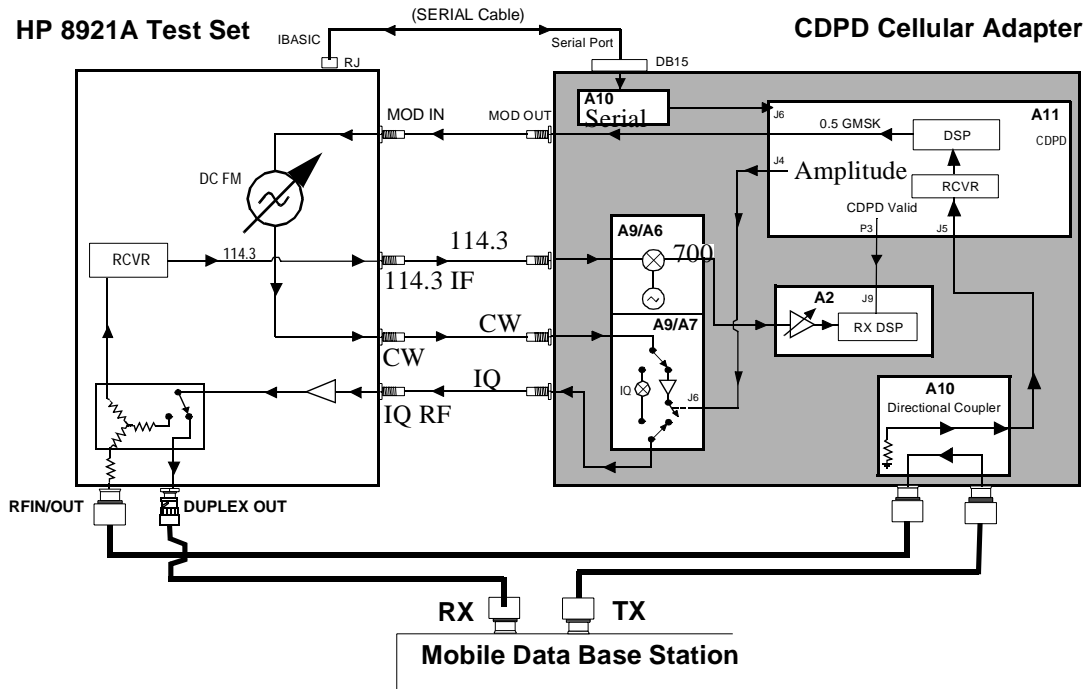

Figure 39 CDPD Test System Overview

Assembly Descriptions

Table 11 describes the major assemblies and subassemblies that make up the Cellular Adapter. Use the diagram shown in **figure on page 114** for a visual overview of the instrument.

Table 11 Quick Reference of Assemblies

Reference Designator	Assembly Name	Function
A2	Receiver DSP (Digital Signal Processor)	Data analyzer
A4	Premodulation Filter	Encodes and filters the I/Q channels
A5	Transmit DSP	Data generator
A9		Houses the A6 & A7 assemblies
A9/A6	Reference/Receiver	Time base reference and receiver/down converter
A9/A7	I/Q Modulator	Modulates the RF carrier with $\pi/4$ DQPSK
A10	Directional Coupler & Serial Switch	The directional coupler couples the CDPD signal for verification. The serial switch switches Test Set communication between the premod filter and the CDPD assembly.
A11	CDPD module	Provides CDPD protocol processing

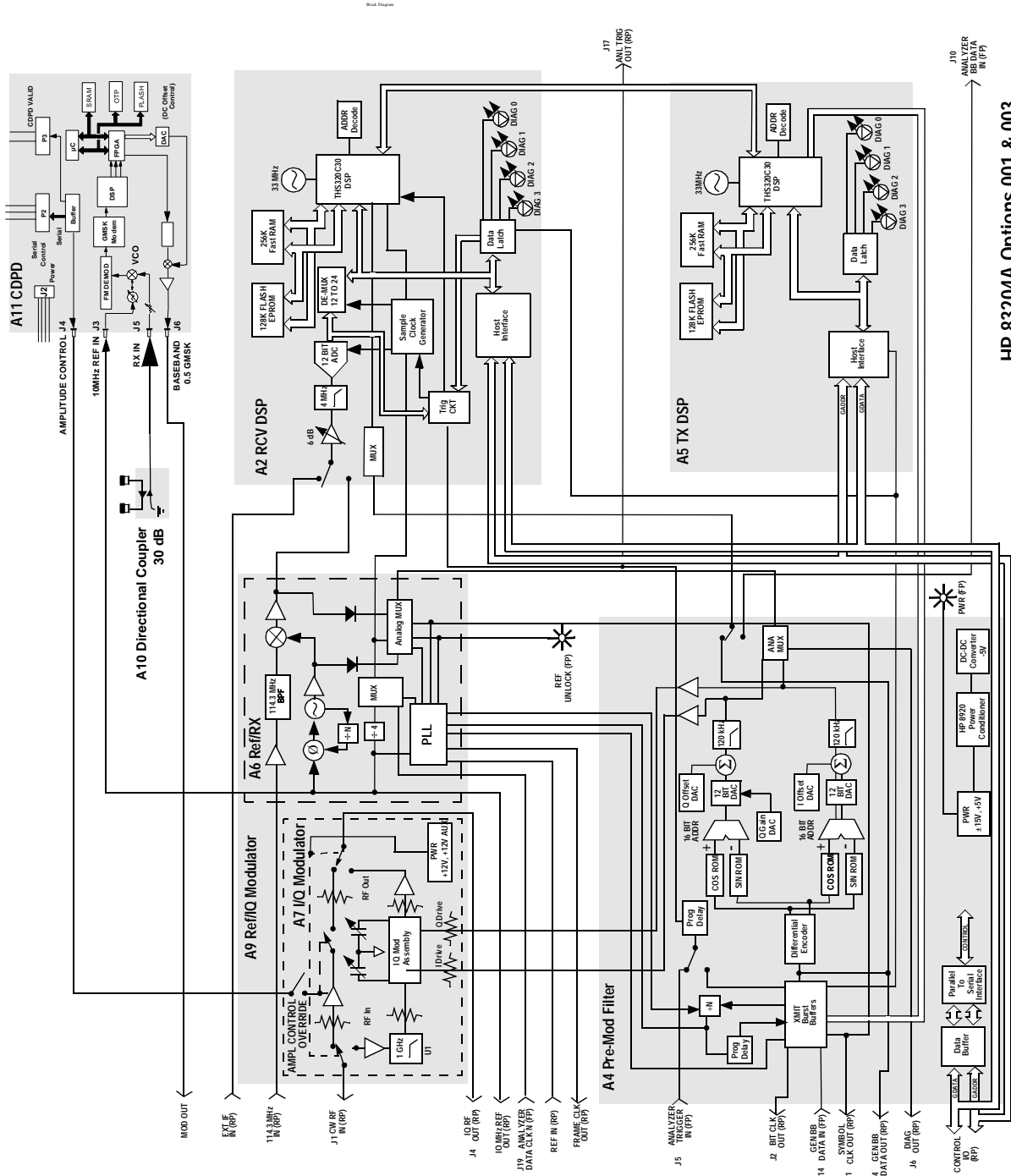

HP 83204A Options 001 & 003

A2 RX DSP Assembly

This data analyzing assembly is known as the receiver digital signal processor (RX DSP). It is controlled by the settings in the Digital Analyzer field on the TDMA Test screen. This assembly is similar to the TX DSP board, but has additional parts. These include an analog-to-digital converter (ADC), attenuator, and filter. The DSP firmware code is stored in flash EPROM. This code can be loaded into the Cellular Adapter's flash EPROM from the a memory card inserted in the Test Set, see "[Firmware Upgrades](#)," in [chapter 4](#), on [page 100](#).

A3 Motherboard

This assembly interconnects the premod filter and the DSP boards. It distributes the AC/DC voltages and control signals. The Test Set has control over the A3 assembly's power relay to apply or disconnect AC power to the Cellular Adapter.

A4 Premodulation Filter Assembly

This assembly selects the data stream's source, buffers the data, differentially encodes the data, and filters it using a digital Nyquist filter. The resulting I and Q channel drive signals go to the I/Q Modulator (A7) after their gain and offset are adjusted by multiplying DACs.

Many of the timing, delay, and data selection fields available on the Test Set's screen are implemented on the A4 assembly. See [table 12](#) for a description of the signals and waveforms expected from the connectors of the A4 assembly.

The Premod filter includes an analog multiplexer for access to diagnostic signals. These signals are utilized by the Test Set's internal diagnostic programs DMC_DIAGL and DMC_DIAGN, see [chapter 2](#), "Troubleshooting" on [page 47](#) for details on these programs.

Table 12 **A4 Assembly Signals and Waveforms**

	Description
J5	ANALYZER TRIGGER IN (front panel) - allows external trigger of the digital analyzer: TTL levels, 100 K Ω
J2	Bit Clk Out (CMOS levels) - 50-ohm square wave output from the bit clock used to synchronize external equipment. Frequency: 48.6 kHz (NADC)
J14	Gen Baseband Data In (CMOS levels)
J1	SYMBOL CLK OUT (back panel, CMOS levels); output for the symbol clock to synchronize external equipment to the digital generator 50-ohm data rate: 24.3 kHz (NADC)
J4	Gen Baseband Data Out (CMOS levels); monitors the digital signal applied to the Premod Filter & I/O Modulator. Data rate: 48.3 kbit/s (NADC)
J6	Control I/O; provides the data communication between the Test Set and the Cellular Adapter. This connection provides +12 Vdc to the I/Q MOD bypass path when the Cellular Adapter is not connected to line power.
J19	Anal_Data_Clk In to A6J7 Ref; connects Analyzer Data Clk In to the reference board.
J15	A_Mux_In from A6J5; passes the analog signals from the ref. board mux to the switch on the Pre_Mod Filter.
J16	Diag Out; Used for servicing and diagnostics. Usually connected to the Test Set's AUDIO IN during diagnostic and calibration tests. Passes analog frequency and voltages.
J10	Analyzer Data Clk In; initiates the Digital Analyzer to sample the Analyzer BaseBand Data In. Clk freq. 48.6 kHz (NADC) TTL levels 100k ohms.
J13	16X Symbol from A6J6 REF; provides reference to the XMIT Burst Buffers in the Premod Filter.
J17	Analyzer Trigger Out (TTL levels); outputs the signal used to synchronize General purpose connector, 2X frame clk, or Ext Analyzer Trigger

A5 TX DSP Assembly

This data generating assembly is known as the transmit digital signal processor (TX DSP). This assembly includes the DSP processor chip and its associated EPROM, RAM, FIFO, and serial communication ports. The DSP firmware code is stored in flash EPROM. This code can be loaded into the Cellular Adapter's flash memory from the firmware memory card inserted into the Test Set, [see "Firmware Upgrades," in chapter 4, on page 100.](#)

A8 Power Supply

This switching supply is a replaceable assembly and provides the +5 Vdc and +/-15 Vdc for the Cellular Adapter. Replacement of the power supply fuse is not supported. [See "Power Supply and Voltage Distribution" on page 124](#) for power distribution information.

A9 Reference I/Q Assembly

The A9 assembly includes two circuit boards in a single cast frame with covers (RF shields). These two assemblies are the A7 I/Q Modulator and A6 Reference/Receiver. These subassemblies are not separately replaceable. See [table 13 on page 119](#) for a description of the signals and waveforms expected from the connectors of the A9 assembly.

The I/Q Modulator lies in the RF path of the Test Set. The CW RF IN signal is generated by the Test Set's signal generator synthesizer. If the RF level into the I/Q Modulator is too high, it will cause distortion and degrades the EVM performance.

The I/Q Modulator includes a switch that selects a bypass path or the I/Q modulator. Both paths include buffer amplifiers. The bypass path is used during CDPD analog operation. It includes an amplitude control switch for CDPD operation. The I/Q modulation path includes a modulator that imposes the $\pi/4$ DQPSK modulation on the RF signal.

In addition to the RF signal, the modulator also has two I and Q modulation drive signals from the pre-premod filter assembly. The modulator has two trim capacitors. These capacitors are adjusted at the factory and should not be re-adjusted.

The Test Set provides +12 Vdc to the I/Q Modulator board to power the bypass path and gain stages when the Cellular Adapter is not connected to line power. This supply is routed through the rear panel data cable and is replaced once the Cellular Adapter is powered up. Without this auxiliary supply, the Test Set's RF output would not meet specifications.

The Reference/Receiver includes two major circuits, the time base reference circuitry and the receiver down converter circuitry. The time base reference circuits use a 10 MHz VCO that is phased locked to the external REF IN. If the Cellular Adapter Ext Ref is too low or not connected, then the Ref OOL front panel LED is turned on. By using various dividers the VCO can lock to the 1, 2, 5, 10 MHz reference frequencies, the 25 or 50 Hz (1x or 2x Frame Clock) frequencies, or the 24.3 or 48.6 kHz (1x or 2x Symbol Clock) frequencies. This gives the time base great flexibility in operating/synchronizing with a wide variety of references in various applications. The time base provides all the trigger and clock selections used on the RX and TX DSP assemblies.

The receiver down converter generates a 115 MHz LO. The LO is used to mix down the 114.3 MHz IF IN signal that comes from the Test Set's first receiver IF. The result of this mixing is the 700 kHz IF that is passed to the RX DSP assembly (analyzer). This down converter includes buffer amps, a SAW filter, and the mixer itself.

The Reference/Receiver assembly also includes an analog multiplexer for access to diagnostic signals. This includes scaled frequencies from the PLLs, and their bias and tune voltages. These signals are utilized by the Test Set's internal ROM diagnostic programs, DMC_DIAGL and DMC_DIAGN.

Table 13 **A9 Assembly Signals and Waveforms**

	Descriptions
A7J1	CW RF IN; Bypass path 500-1000MHz I/Q Mod. path 823-895MHz
A7J4	IQ RF OUTPUT; Bypass 500-1000 MHz/Gain >2 dB I/Q Mod. 823-895 MHz/ -8 to -11 dBm (quadrature set as center, 859 MHz)
A7J2, A7J3	I and Q Inputs; -5 dBm input, 50 ohm input
A6J10	700 kHz IF output; Downconverted from the 114.3 MHz IF with $\pi/4$ DQPSK modulated carrier. -25.5 to 5.5 dBm into 50-ohms.
A6J5	Analog MUX Out; Various analog signals between +/-12V. Frequencies are divided by 100 before being routed to the 8920 counter/voltmeter for diagnostic purposes. The mux connectors are: <ul style="list-style-type: none"> • Vt10M (TCXO tune line) • VtSYM (Symbol Clock Cleanup VCO tune line) • ExtFs (HCMOS sample clks/100) • Lo_SENSE (115 MHz lo drive level to mixer) • DSP_IF_S (700 kHz IF level) • VtLO (115 MHz tune line) • Vb_S (115 MHz VCO transistor collector)

Table 13 **A9 Assembly Signals and Waveforms**

	Descriptions
A6J8	114.3 MHz In; Downconverted IF with $\pi/4$ DQPSK modulation form the 8920 Receiver. -15 dBm max level, typical -53 to -25 dBm
A6J7	RX_DATA_CLK; CMOS levels, Various frequencies.
A6J2	EXE. REF. IN (CMOS levels); Freq. 25.0 Hz (PDC/NADC frame clk) 50.0 Hz (PDC/NADC 2 *frame clk) 200.0 Hz (PHP frame clk) 400.0 Hz (PHP 2 *frame clk) 21.0 kHz (PDC symbol clk) 24.3 kHz (NADC symbol clk) 192.0 kHz (PHP symbol clk) 42.0 kHz (PDC bit clk) 48.6 kHz (NADC bit clk) 3834.0 kHz (PHP bit clk) Frequency Range ± 1 PPM.
A6J9	FsCLK OUT (CMOS levels); freq. 5 x symbol (105.0 kHz/PDC) (121.5 kHz/NADC) (960.0 kHz/PHP) 1.0 MHz 2.0 MHz 2.5 MHz RX_DATA_CLK_ - various frequencies, 50-ohms
A6J4	10 MHz Out; Waveform - Sine Level > +5 dBm Freq. 10 MHz Freq. Stability same as EXT_REF.
A6J3	Frame Clk Out (CMOS levels); 25.0 Hz (PDC/NADC) 200.0 Hz (PHP). 50-ohms.

Table 13 **A9 Assembly Signals and Waveforms**

	Descriptions
A6J6	16 x Symbol (CMOS levels); Frequency: 388.8 kHz (NADC), 50-ohms
A6J1	PIN3 REF_LOCK (CMOS, 1=lock, 0=unlock) PIN5 SYMBOL_B (CMOS) 24.3 kHz (NADC) PIN\$ FRM_RESET (CMOS) (CMOS levels, low for reset)

A10 Directional Coupler & Serial Switch

The directional coupler passes part of the received CDPD signal to the CDPD assembly while blocking the transmitted signal. This allows the CDPD module to detect valid CDPD signals. The serial switch board allows the Test Set to send commands to either the CDPD module or the Premod Filter assembly.

A11 CDPD Assembly

The A11 CDPD assembly performs all of the CDPD signal generation and detects a valid CDPD signal from the base station, see [figure 40](#) . The only way to control the CDPD assembly is over the serial bus using the IBASIC controller built into the Test Set. See [table 14 on page 123](#) for a description of the signals and waveforms expected from the connectors of the A11 assembly.

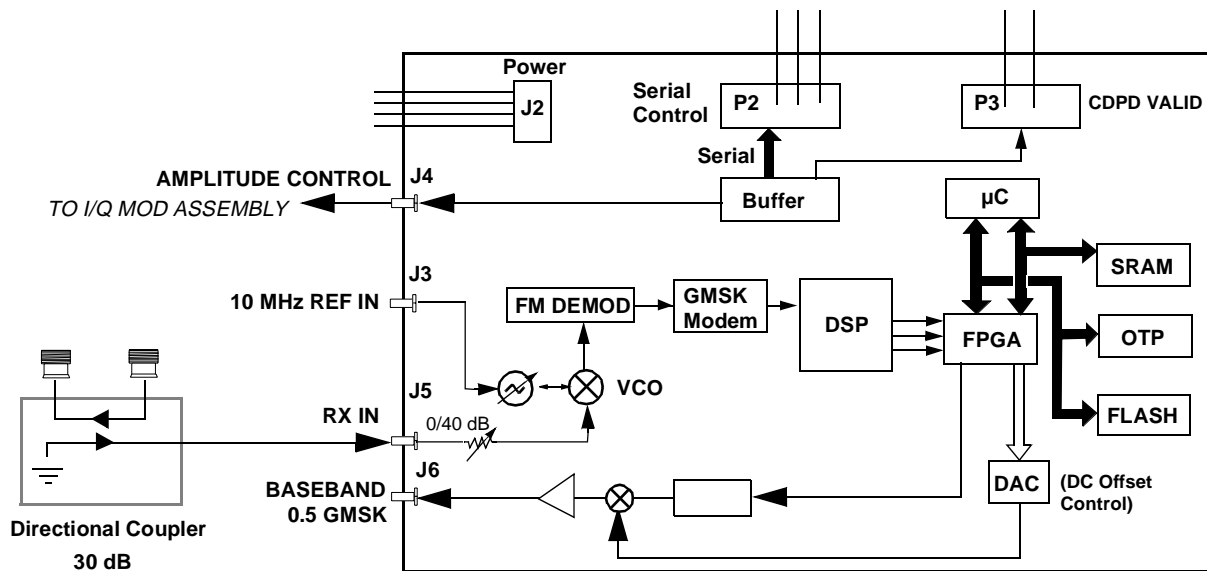

Figure 40 A11 CDPD Assembly Block Diagram

Table 14 **A11 Assembly Signals and Waveforms**

	Signal Description
J6	Baseband .5 GMSK - Unmodulated CDPD data signal that is passed to the test set for modulation and transmission. Will be active when running the RF loopback test in the diagnostics.
J5	Receiver In - Modulated CDPD data signal received from the directional coupler (A10). Will be active when running the RF loopback test in the diagnostics.
J3	10 MHz Reference In - 10 MHz reference signal from the Ref/RX module (A6 - Part of A9).
J4	Amplitude Control - DC control signal for fast switching of the CDPD RF signal.
J2	Power -15V, GND, +5V, +15V
P2	Serial Communications - Serial control bus to/from the Serial Switch Board (A10).
P3	Valid CDPD - Notifies the DSP that a valid CDPD signal is being received. This is a DC signal.

Power Supply and Voltage Distribution

The Cellular Adapter does not have its own power-up switch. The power-up command is received through the I/O CONTROL cable on the back panel. For an overview of power distribution, see figure on page 125.

WARNING

There are AC voltages present inside the instrument when the power cord is connected to a power source. Extreme caution should be used in the area of the A3J1, A3J7, and A3K1 on the A3 Motherboard, and by the fuse holder near the power cord. The A8 power supply assembly does not have AC voltage present unless the POWER switch on the Test Set is pressed.

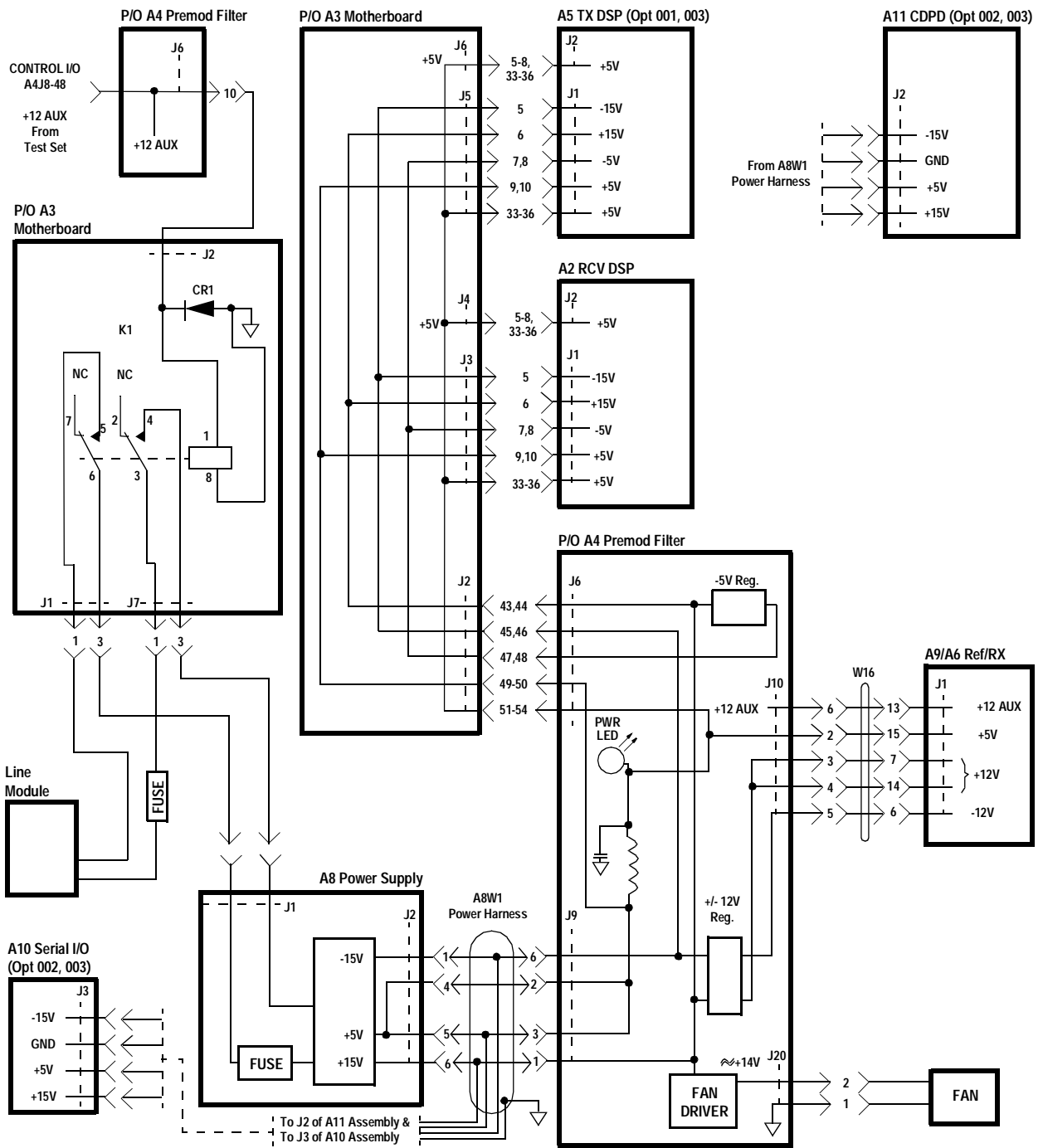

Replaceable Parts

This chapter contains the replaceable assembly and component information for the HP 83204A TDMA (Opt 001), CDPD (Opt 002), and TDMA/CDPD (Opt 003) Cellular Adapters. Use the illustrations on the following pages to identify the replaceable parts and the [see "Replaceable Parts List" on page 143](#) for part numbers.

Parts Identification

Major Assemblies

Figures 46 and 47 show the major assemblies for the HP 83204A TDMA Cellular Adapter.

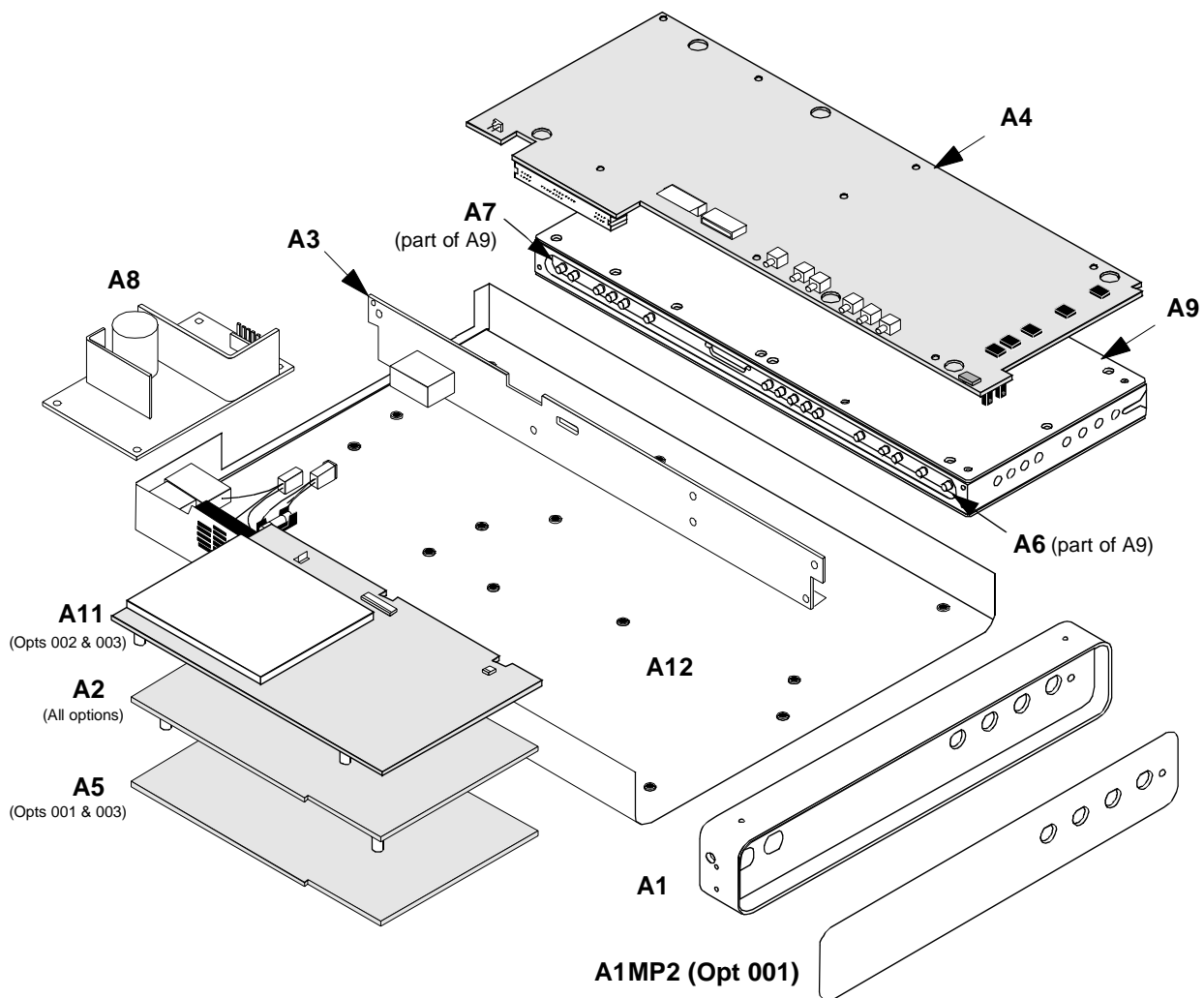

Figure 41 HP 83204A Cellular Adapter Major Assemblies

CDPD Components

NOTE: The CDPD components shown below are found in Options 002 and 003 of the HP 83204A Cellular Adapter.

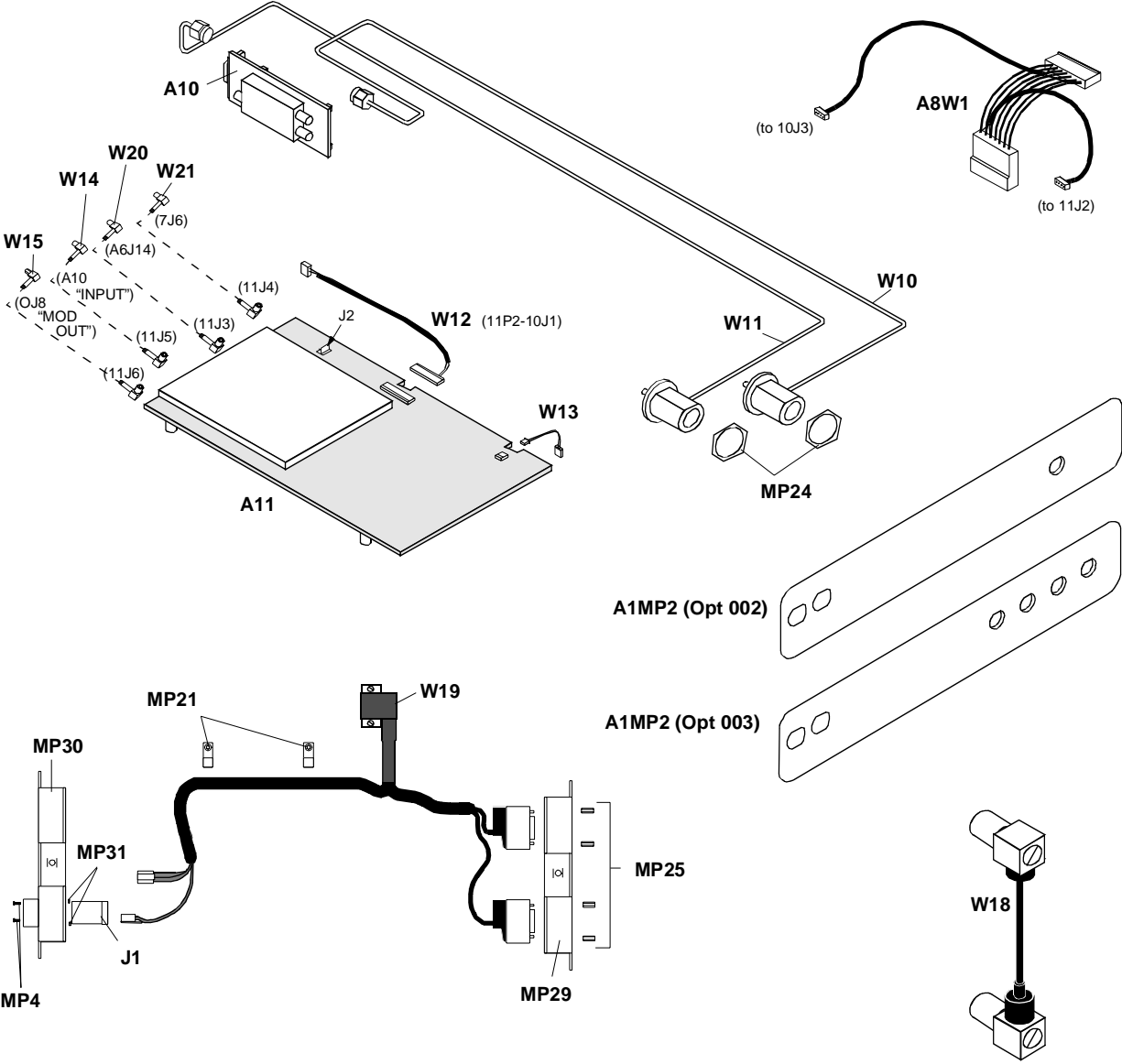

Figure 42 CDPD Assemblies and Components

External Cables

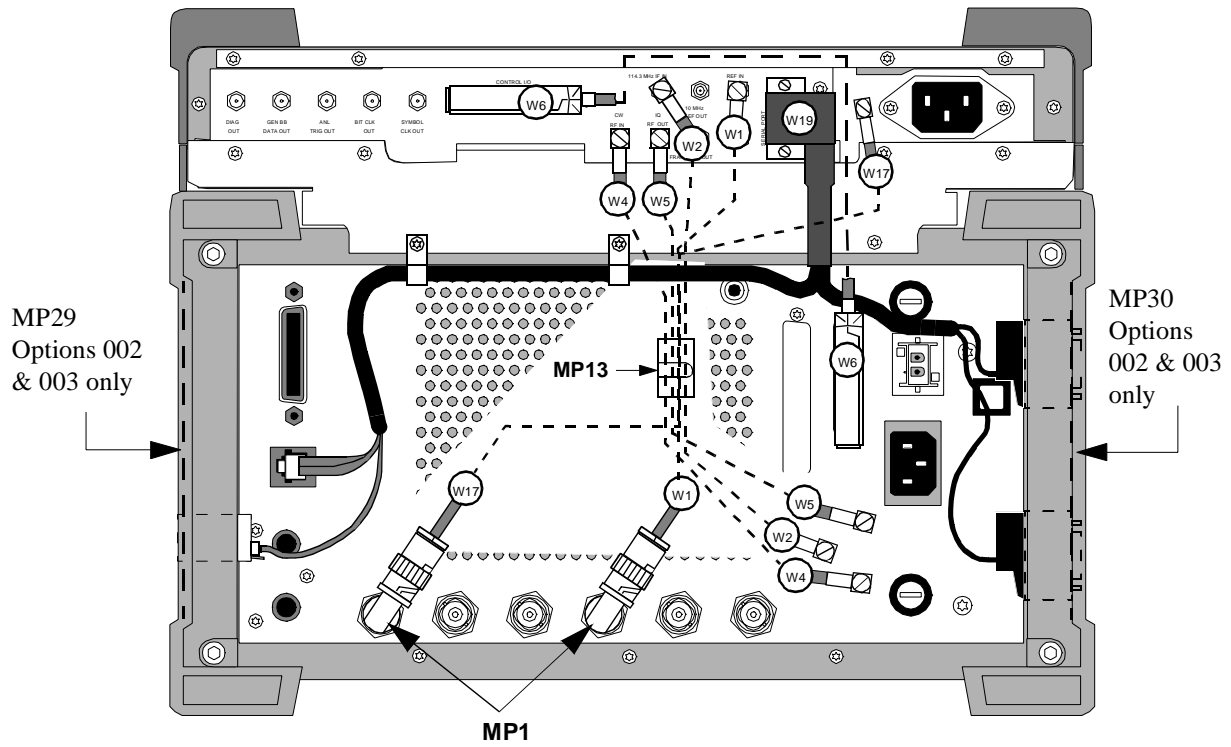

Figure 43 Back Panel Cables of HP 83204A Cellular Adapter (Option 003) and HP 8921 Cell Site Test Set

Front Panel Components

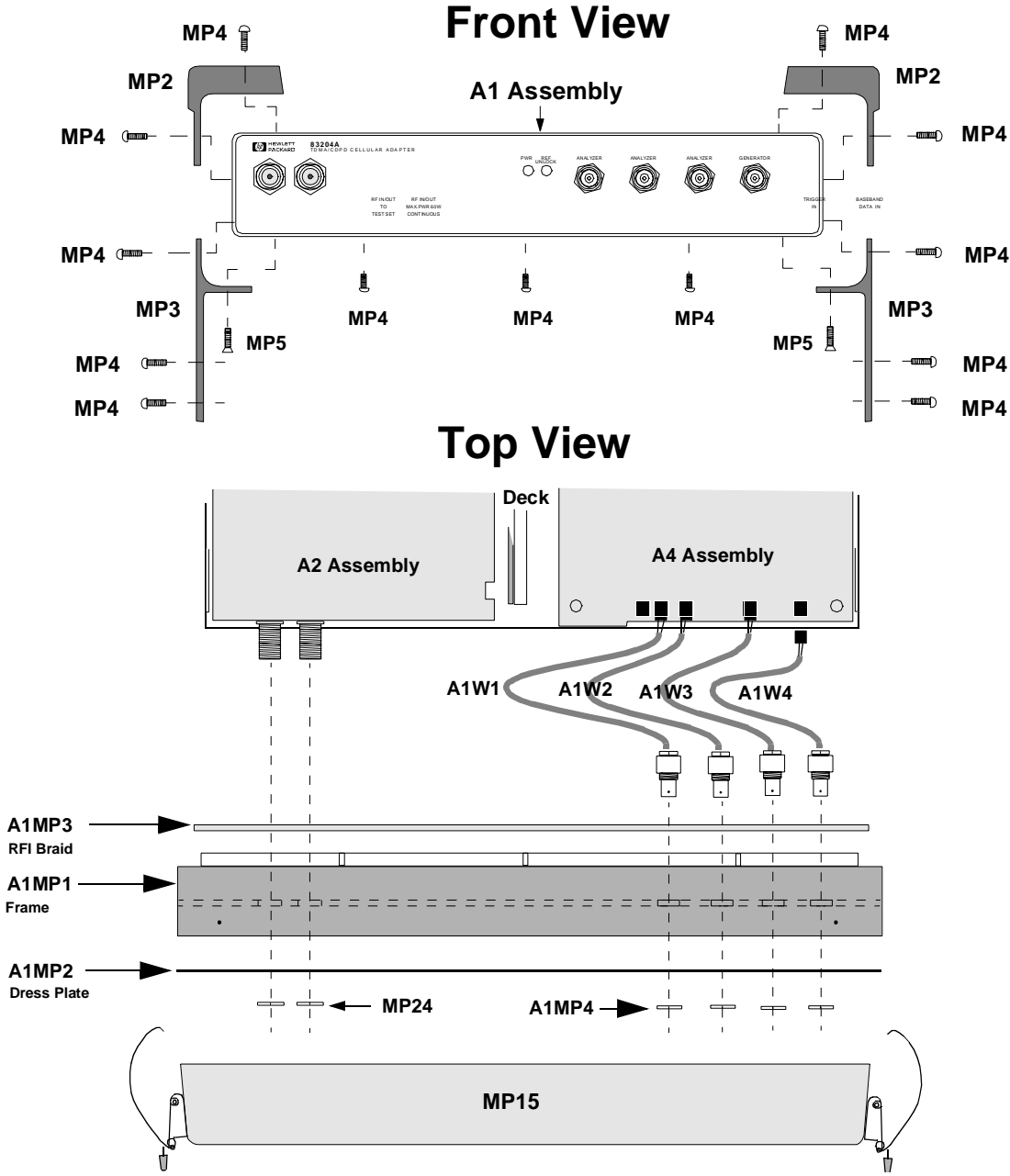

Figure 44 Front Panel Components

Cover and Back Panel Components

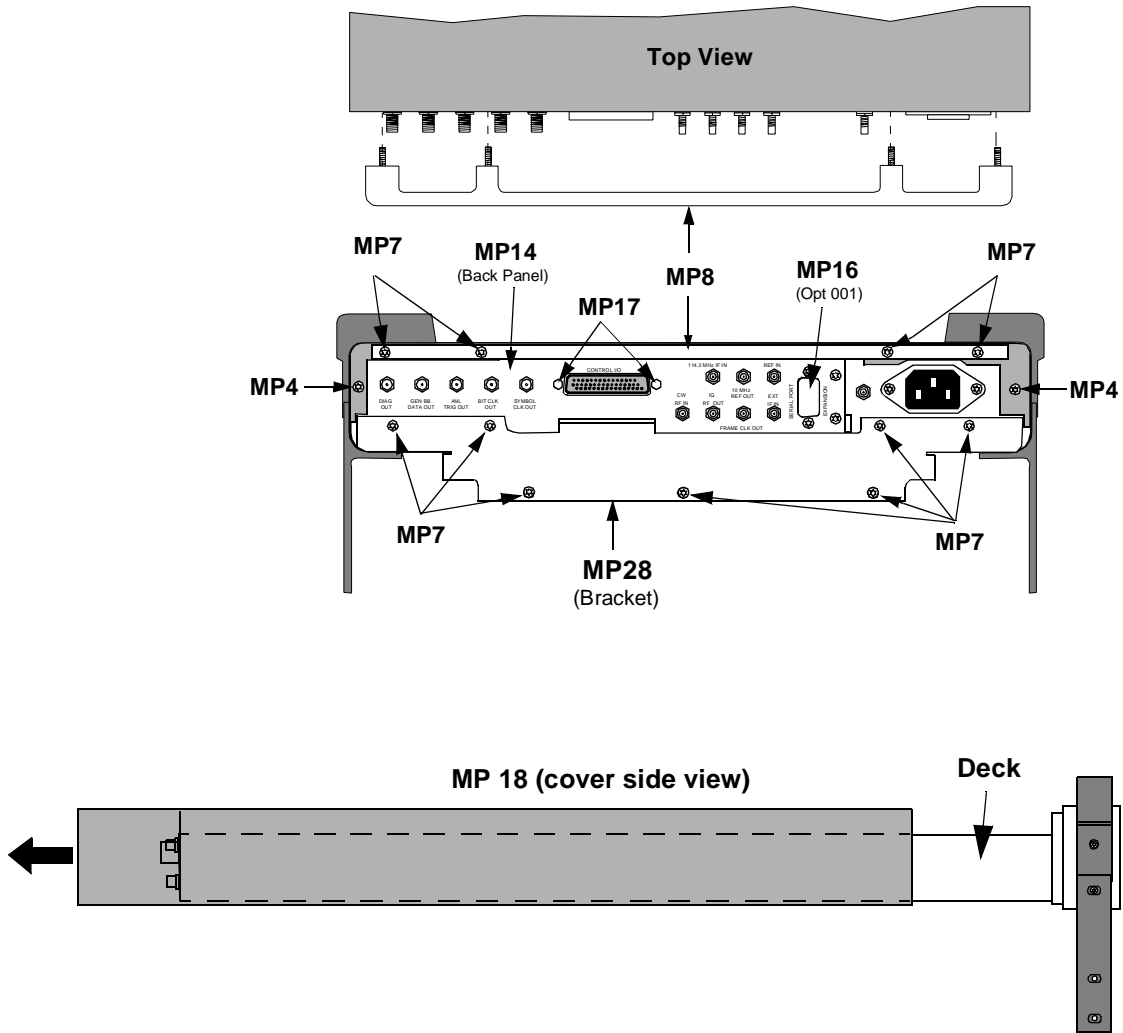

Figure 45 Cover and Back Panel Components

Back Panel Components

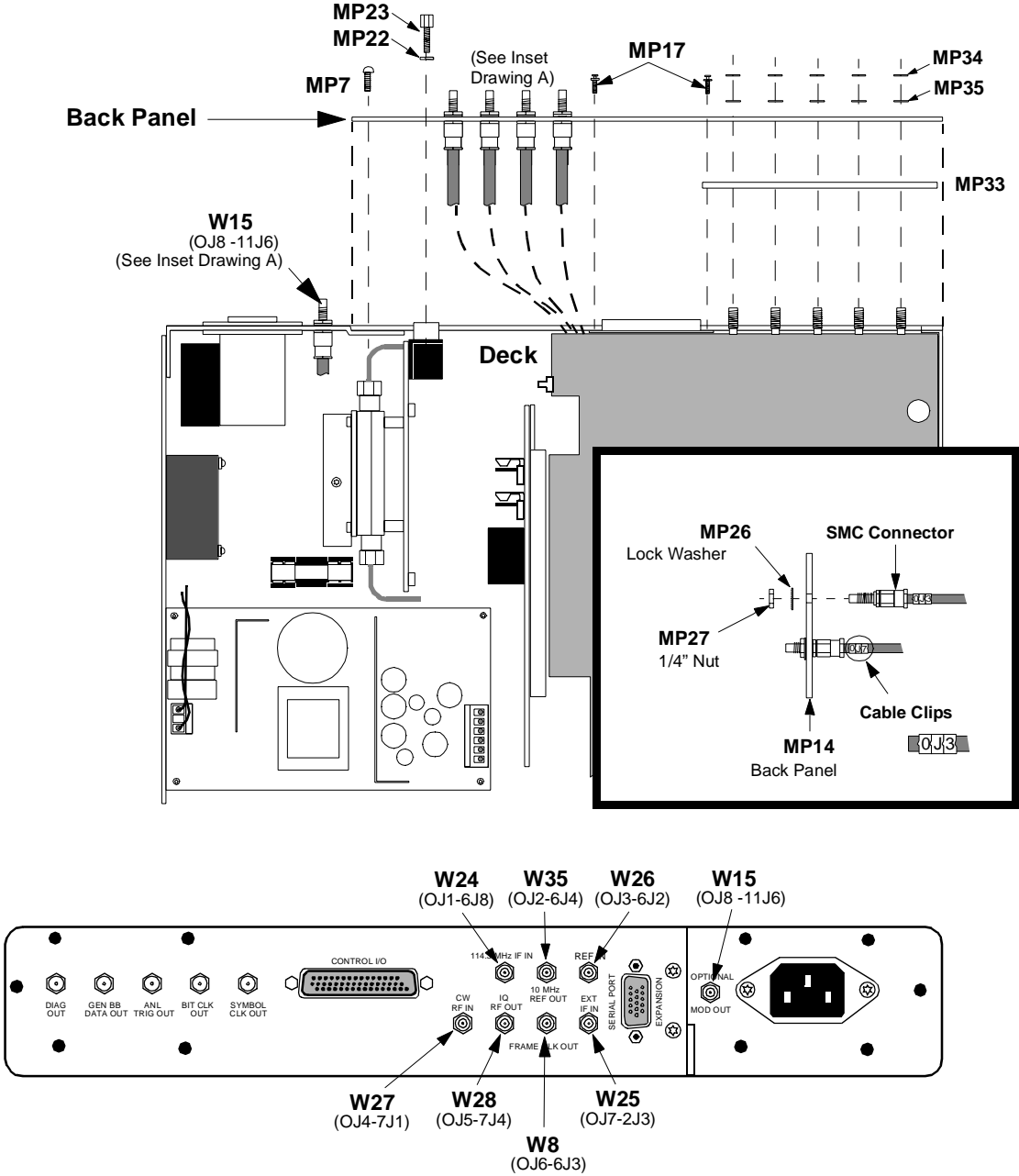

Figure 46 Back Panel Components

A8 Assembly & Miscellaneous Components

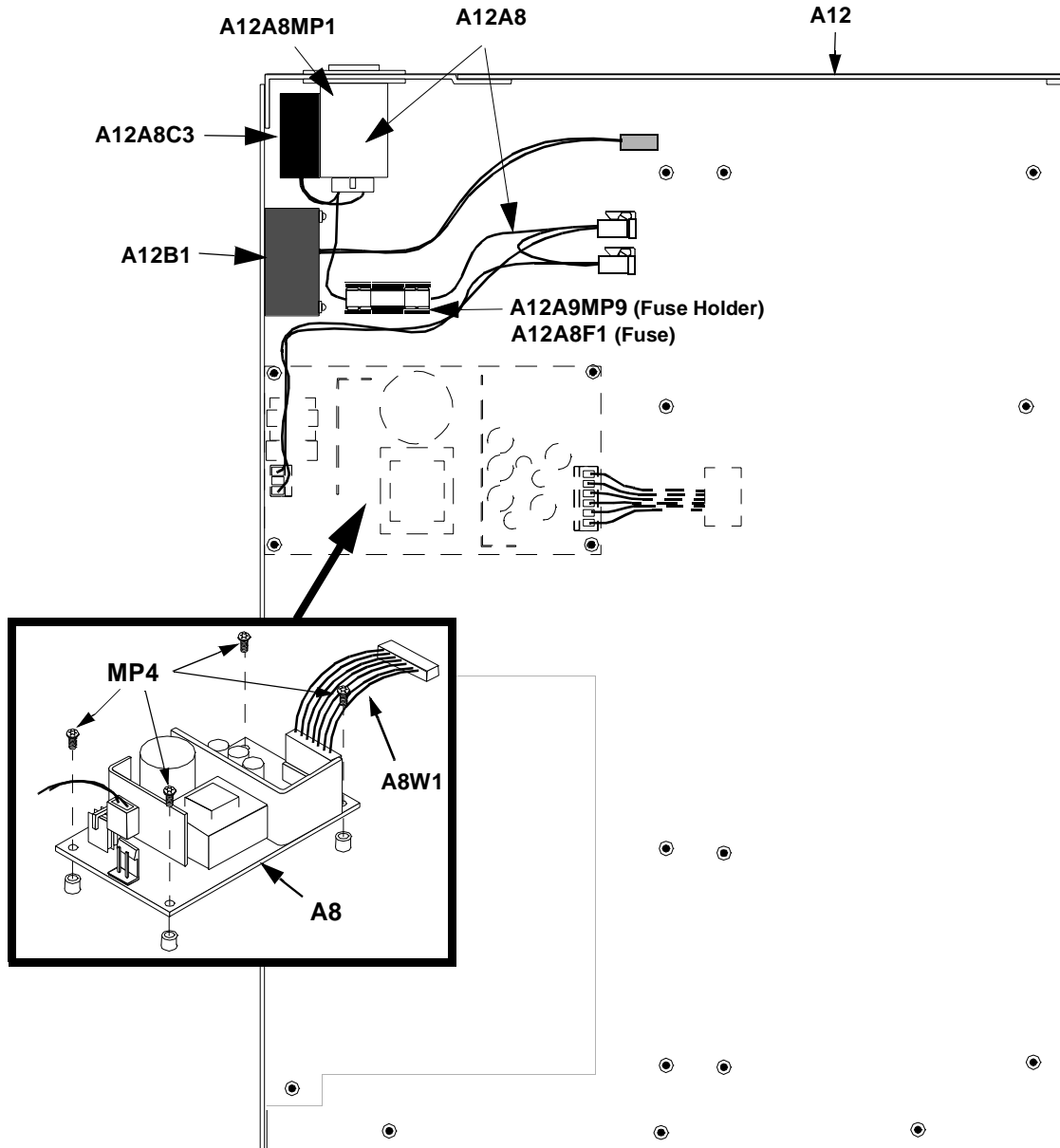

Figure 47 A8 Power Supply Assembly & Miscellaneous Components

A4 Assembly and Components

NOTE

Perform the PER_CALD calibration after replacing the A4 assembly (see chapter 7, "Calibration and Performance Tests," on page 147).

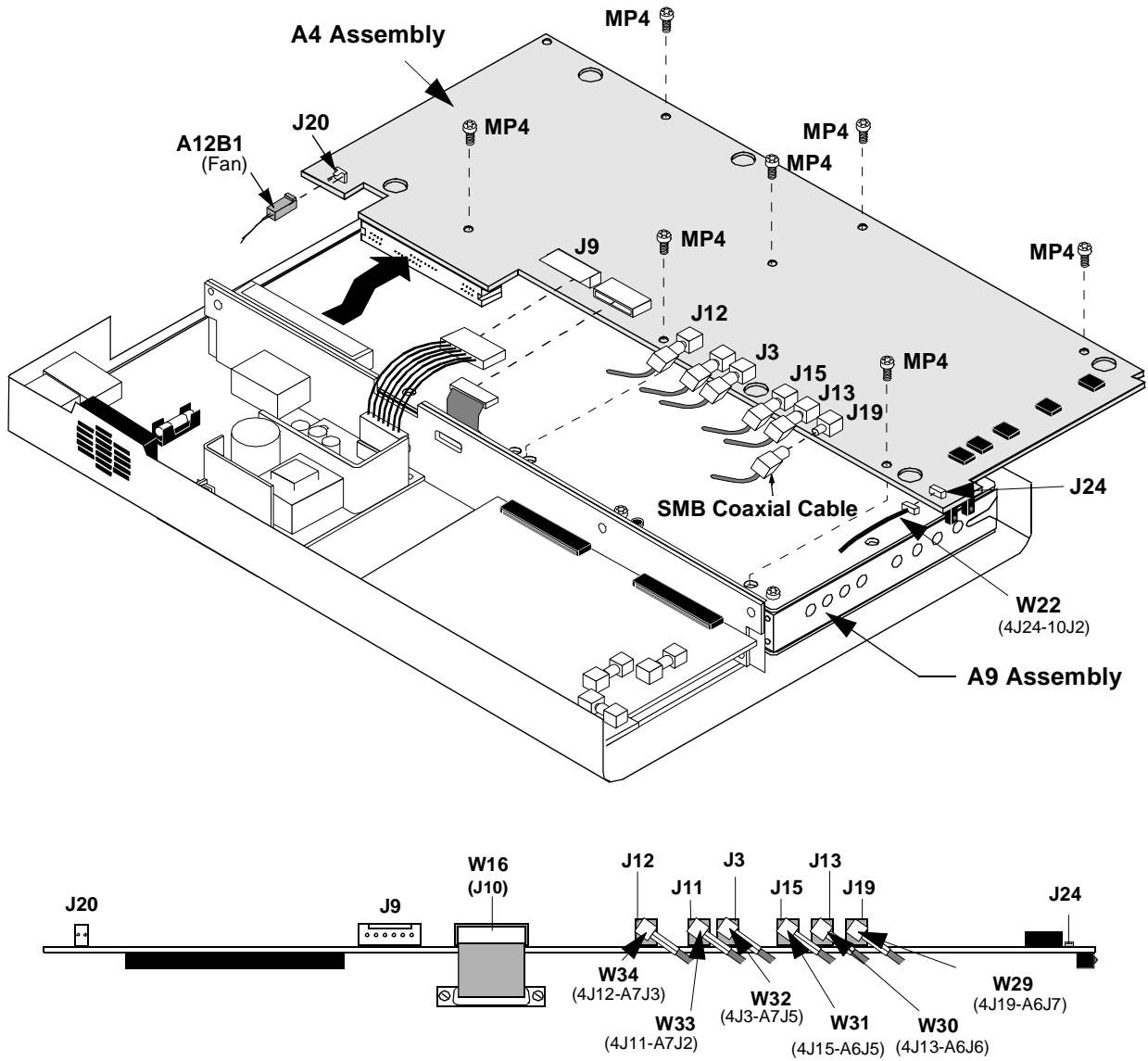

Figure 48 A4 Pre-mod Filter Assembly

A9 Assembly

NOTE

Perform the PER_CALD calibration procedure after replacing the A9 assembly (see chapter 7, "Calibration and Performance Tests," on page 147).

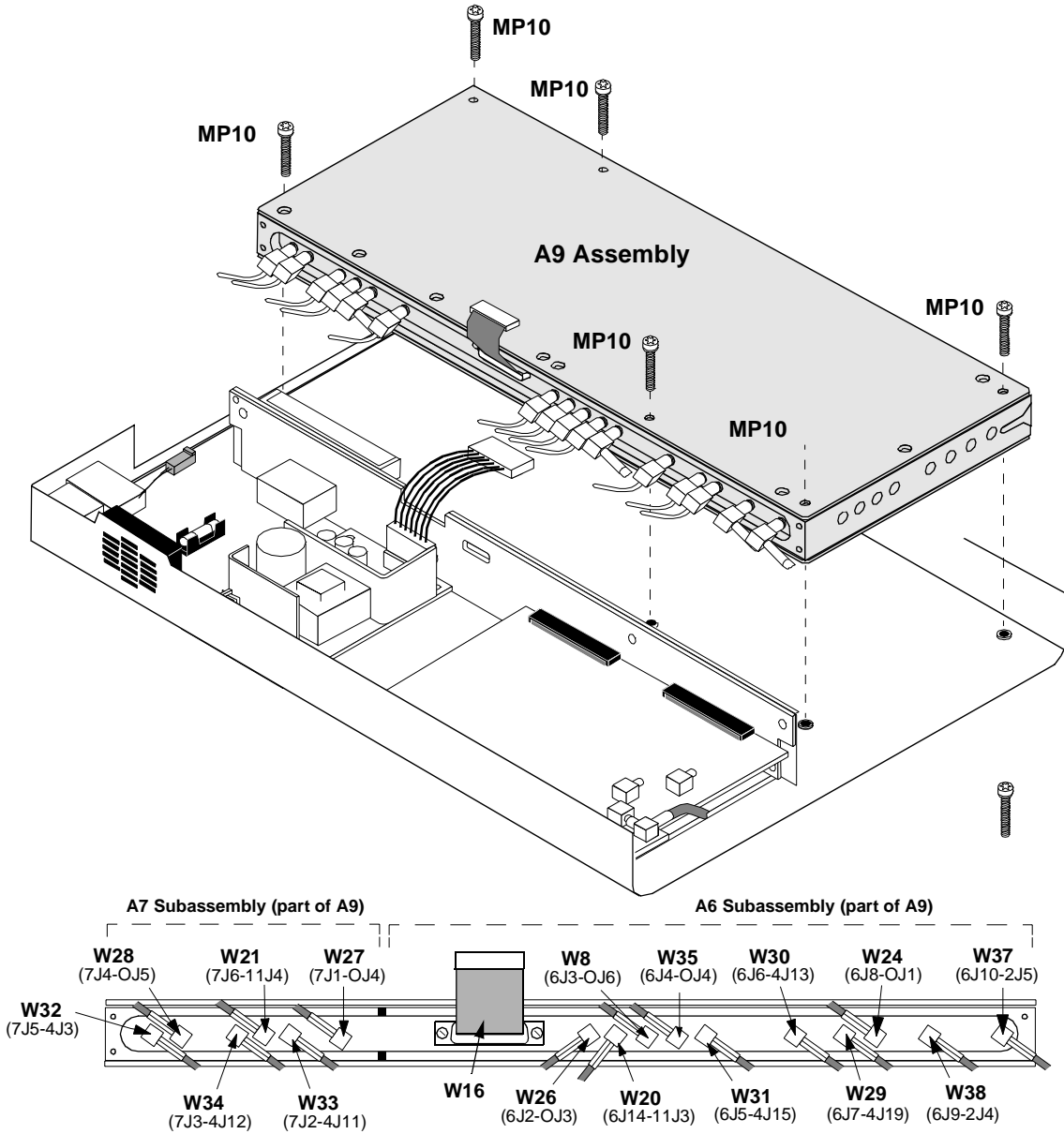

Figure 49 A9 IQ Modulator/Reference Assembly

A10 Assembly, Options 002 & 003

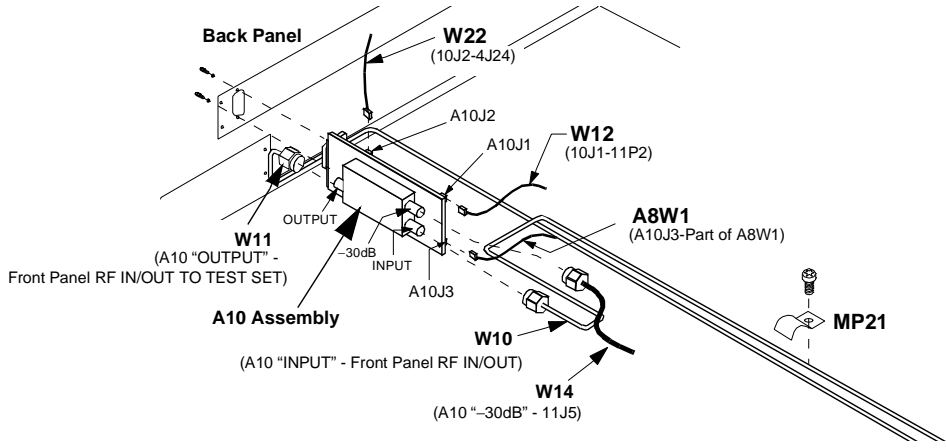

Figure 50 A10 Directional Coupler & Switch Assembly (Options 002 & 003)

A11 Assembly, Options 002 & 003

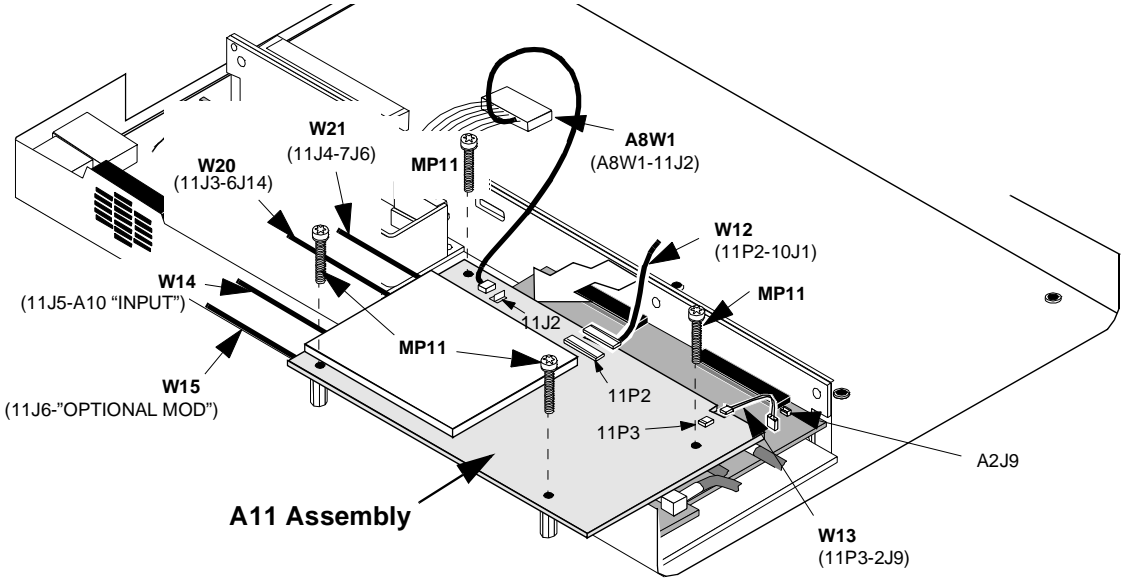

Figure 51 **A11 CDPD Assembly (Options 002 & 003)**

A2 Assembly

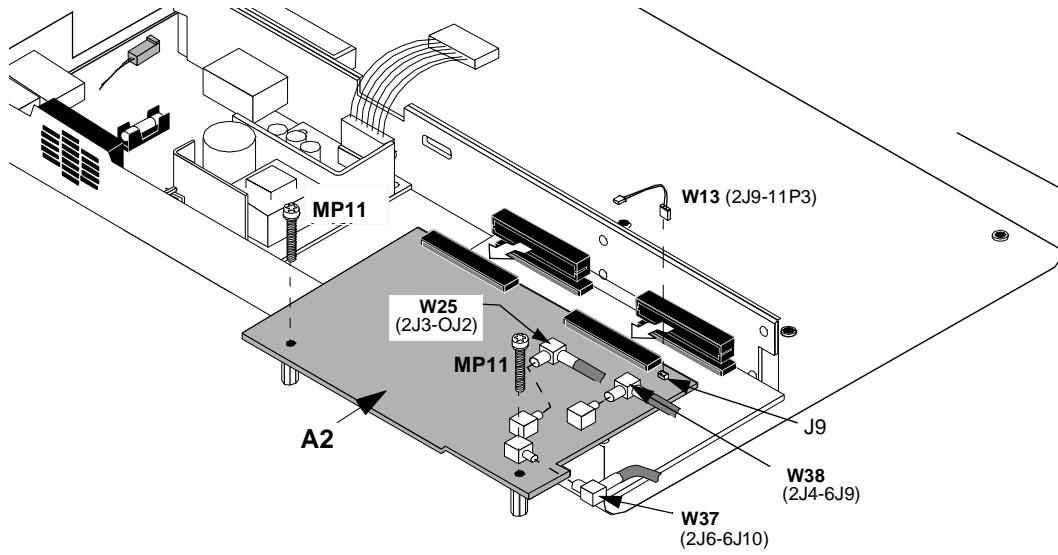

Figure 52 A2 Rx DSP Assembly

A5 Assembly

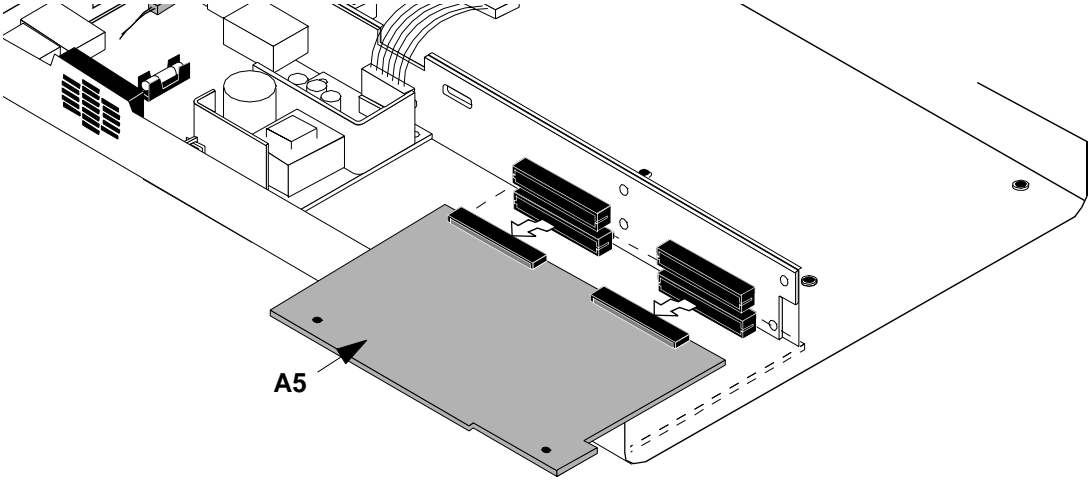

Figure 53 **A5 Tx DSP Assembly**

A3 Assembly	Item	Description	Part Number
-------------	------	-------------	-------------

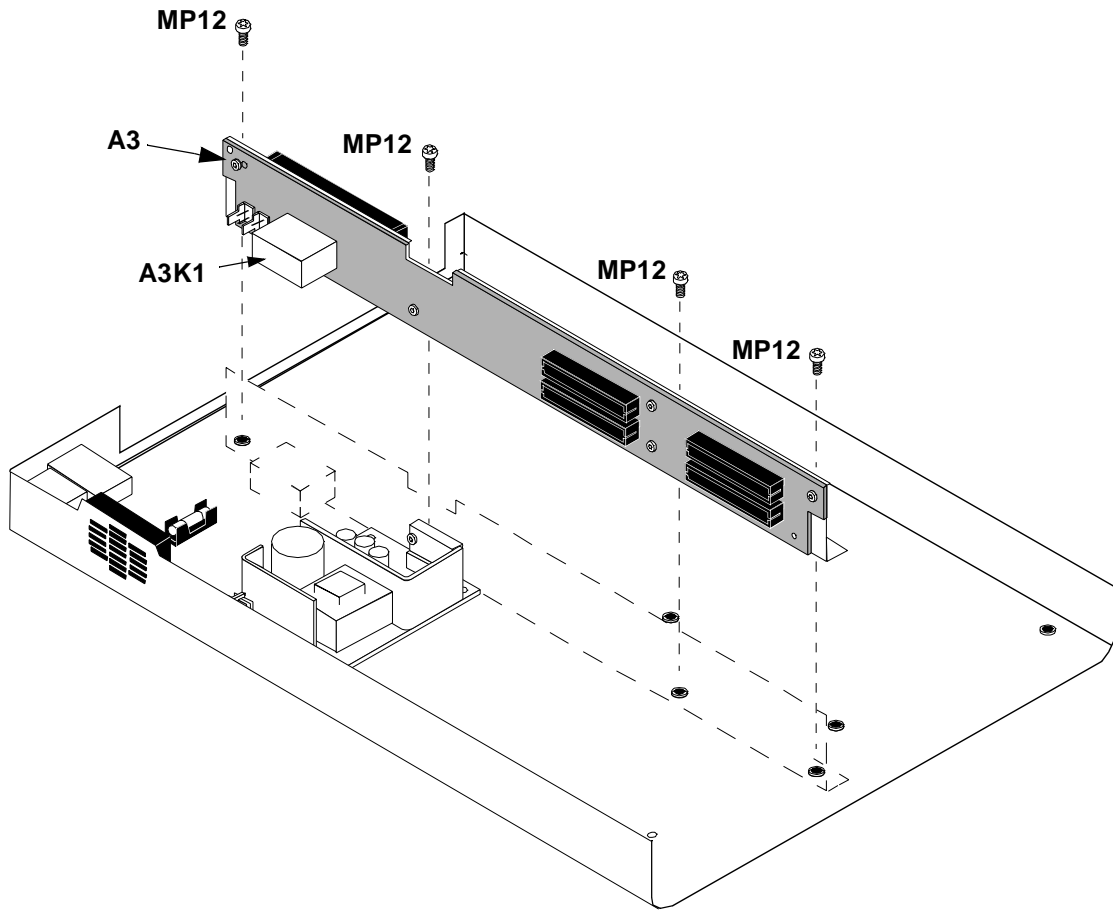

Figure 54 **A3 Motherboard Assembly**

Item	Description	Part Number
Replaceable Parts List		
ACC1	ALR Manual	83204-90018
ACC2	USER'S GUIDE	83204-90009
ACC3	SW USER GUIDE	83204-90014
ACC4	DSP UPGRADE KIT	83204-61802
ACC5	CDPD SFTWARE KIT	83204-61807
ACC6	KIT-RACK MOUNT	08921-61037
ACC7	ACCESSORY KIT	83204-61008
ACC7AT1	ATTN COAX 6dB 1W	0955-0698
ACC7MP1	ADPT TEE FMF BNC	1250-0781
ACC7MP2	TERMINATION	0960-0053
ACC7MP3	ADPT M BNC F SMA	1250-1700
ACC7MP4	ADAPTER	1250-1250
ACC7W1	CA MCND RJ11-DB9	08921-61038
ACC7W2	CA CX ASSY 50Z	8120-2582
ACC7W3	CA CX AY 50Z 1FT	8120-1838
ACC7W4	CBL FLEX COAX	08921-61052
A1 (#002)	AY FRNT PNL #002	83204-61006
A1 (#001)	AY FRNT PNL #001	83204-61005
A1 (#003)	AY FRNT PNL #003	83204-61002
A1MP1 (#001)	FRAME FRONT	83201-21007
A1MP1 (#002 /#003)	FRAME FRONT MACH	83203-21003
A1MP2 (#001)	PANEL DRESS	83204-00003
A1MP2 (#002)	PANEL DRESS	83204-00001
A1MP2 (#003)	PANEL DRESS	83201-00020

Item	Description	Part Number
A1MP3	RFI ROUND STRIP	8160-0520
A1MP4	NUT-HEX 15/32-32	2950-0035
A1W1-A1W4	CBL ASSY	83203-61005
A2	RX DSP KIT	83204-61804
A3	MOTHERBD KIT	83206-61805
A3K1	RLY ZC 12VDC	0490-1787
A4	NEW PREMOD FILTER KIT	83201-61808
A5	TX DSP KIT	83204-61803
A8	PWR SPLY 3 40W	0950-2023
A8W1 (#001)	CA MCNDCT 6CKT	83201-61011
A8W1 (#002/#003)	CBL POWER SUPPLY	83203-61042
A9	IQ MOD/REF KIT	83204-61806
A10 (#002/#003)	DIRECT COUPLR KIT	83205-61802
A11 (#002/#003)	RESTORED CDPD KIT	83204-69805
A11 (#002/#003)	NEW CDPD KIT	83204-61805
A12	DECK	83203-00021
A12A8	CABLE MAIN HARNESS	83203-61058
A12A8C3	C MPAP .47U 250V	0160-7716
A12A8F1	FUSE 2A 250V	2110-0002
A12A8MP1	FLTR-LINE 250V	9135-0242
A12A8MP9	FUHLR 15A 250V	2110-0776
A12B1	FAN ASSY	83201-61046
J1 (#002/#003)	ACCESS-TEL CONN	1252-7200
MP1	ADPT F BNC M BNC	1250-0076
MP2	BUMPER	5041-8928
MP3	BRACKET ATTACH	83201-21002
MP4	SMM3.0 8SEMPNTX	0515-0372

Item	Description	Part Number
MP5	SMM3.0 10 FL TX	0515-1103
MP7	SMM3.0 12SEMPNTX	0515-0664
MP8	BAR-CONNECTOR	83201-21004
MP10	SCRMACH M3 30MML	0515-1349
MP11	SCR-MACHINE	0515-1410
MP12	SMM3.0 6SEMPNTX	0515-2126
MP13	CLAMP-CABLE	1400-1391
MP14	PANEL REAR	83201-00019
MP15	AY-COVER,IMPACT	83201-61013
MP16 (#001)	PLATE CONN	83204-00002
MP17	CONN LOCK SUB D	1251-0218
MP18	COVER AY	83203-61051
MP21 (#002/#003)	CLP CA .25D .37W	1400-0015
MP22 (#002/#003)	WSHR-LK HLCL #4	2190-0003
MP23 (#002/#003)	CONN SCREWLOCK F	0380-2079
MP24 (#002/#003)	NUT-HEX 5/8-24	2950-0213
MP25 (#002/#003)	CONNECTOR SCREW LOCL	1252-7215
MP26	WSHR-LK IN T #10	2190-0124
MP27	NUT-HEX 10-32	2950-0078
MP28	PLATE RR MTG	83203-00020
MP29 (#002/#003)	BRACKET SER PORT	83203-00028
MP30 (#002/#003)	BRACKET SER PORT RJ-11	83203-00029
MP31 (#002/#003)	NUTM- HX M3	0535-0031
MP33	SPACER	83201-00013
MP34	NUT RF CONN SMA	1250-0569
MP35	WASHER-LOCK	1250-1142
W1,W17	CABLE	8120-6285

Item	Description	Part Number
W2,W4,W5 W20,W21	CA CX A23A23 195	8120-5730
W6	CA MCNDCT 37CKT	83201-61001
W8,W24,W25, W26,W35	FLEX CABLE	83203-61013
W10 (#002/#003)	CA SR-2.18 N-SMA	83203-61046
W11 (#002/#003)	CA SR-2.18 N-SMA	83203-61045
W12	CA ASSY 3COND	83203-61048
W13	CBL RCV/CDPD	83203-61049
W14	CA COAX SMA-SMC	83203-61047
W15,W27, W28 (#002/#003)	CX F SMC-SMCBH 8	8120-5857
W16	RBN 15CNDCT 28AWG	83201-61004
W18	CX FLEX N-N	8120-8317
W19	CBL SERIAL PORTS	83203-61044
W22	CA ASSY 4-COND	83203-61043
W28,W29,W30, W31,W33,W34, W37	CA CX A06A06 260	8120-5020
W32	CA CX A06A06 310	8120-5021
W38	CA CX A06A06 260	8120-5020

Calibration and Performance Tests

This chapter contains the calibration procedure and the TDMA and CDPD performance test procedures for all options of the HP 83204A Cellular Adapter.

Introduction

NOTE: Perform the **"Periodic Self Calibration" on page 149** before performing any of the following performance tests.

The performance tests in this chapter verify that the HP 83204A Cellular Adapter performs to its specifications. Use **table 15** to determine the performance tests to run for each of the following Cellular Adapters:

- HP 83204A TDMA Cellular AdapterOption 001
- HP 83204A CDPD Cellular Adapter Option 002
- HP 83204A TDMA/CDPD Cellular Adapter Option 003

The **"TDMA Performance Tests Record" on page 168** and **"CDPD Performance Test Record" on page 169** are provided for logging the results of these tests.

Table 15 Performance Tests

Performance Test Name	HP 83204A Cellular Adapter		
	Option 001	Option 002	Option 003
"TDMA Analyzer Accuracy Performance Test 1" on page 151	X		X
"TDMA Generator Accuracy Performance Test 2" on page 157	X		X
"CDPD Performance Test" on page 162		X	X

Periodic Self Calibration

The HP 83204A Cellular Adapter is calibrated by running the PER_CALD calibration program. This program is stored in the HP 8921A Test Set's ROM and should be run at least every 24 months or whenever the Test Set and Cellular Adapter are disconnected and reassembled. The "IQ Gain and Offset" are set using this program.

PER_CALD Calibration Procedure

1. Press the TESTS to access the TESTS screen.
2. Select the Procedure Location: field.
3. Select ROM under the Choices: menu.
4. Select the Procedure Filename: field.
5. Select PER_CALD under the Choices: menu.
6. Select Run Test (k1 USER key).
7. Follow the instructions on the screen.

TDMA Performance Test Procedures

Special Test Equipment

The test equipment in [table 16](#) is needed for performance test number 1 (see "[TDMA Analyzer Accuracy Performance Test 1](#)" on page 151). The following test procedures give critical instrument settings and connections but do not explain how to operate the instruments. For operating instructions, refer to each instrument's operating manual.

To find alternatives to the equipment listed below, look up their specifications in the Hewlett-Packard Test and Measurement Catalog and use the specifications to find equivalent instruments.

Table 16 **Test Equipment**

Equipment Model Number	Model Name	Performance Test Number
(N/A)	$\pi/4$ DQPSK I/Q Modulator	1
HP 8642A, HP 8644A/B, HP 8662A ¹ or HP 8657D	Signal Generator	1

1. See RF signal generator specifications.

RF Signal Generator Specifications

The RF signal generator is used to provide a clean 800 MHz CW signal to the $\pi/4$ DQPSK I/Q Modulator. This 800 MHz CW source must have low residual FM to ensure that the modulated signal will have a good Error Vector Magnitude. The following sources provide an acceptable 800 MHz CW signal:

- the HP 8657D back-panel port: 800 MHz OUTPUT
- the HP 8642A front-panel port: RF OUTPUT
- the HP 8644A/B front-panel port: RF OUTPUT
- the HP 8662A front-panel port: RF OUTPUT

NOTE: Do not use the front-panel RF OUTPUT of the HP 8657D $\pi/4$ DQPSK Signal Generator for either the CW 800 MHz signal or the modulated 800 MHz signal. This signal does not have sufficient accuracy to be used for the performance tests.

TDMA Analyzer Accuracy Performance Test 1

The $\pi/4$ DQPSK I/Q Modulator is used to generate an accurate TDMA modulated signal at 800 MHz. This signal is measured by the unit-under-test (UUT) to determine the accuracy of the UUT's analyzer.

The RF signal generator has low residual FM (<5 Hz). It is used to drive the 800 MHz input of the $\pi/4$ DQPSK I/Q Modulator to produce a TDMA signal with EVM (Error Vector Magnitude) accuracy of approximately 1% (used for the modulation). A 14 kHz audio signal (from the Test Set's AUDIO OUT) provides random data. The clock for this signal is provided by the BIT CLOCK OUPUT of the Cellular Adapter.

Equipment Setup

Connect the Cellular Adapter, signal generator, and $\pi/4$ DQPSK I/Q Modulator as shown in [figure 55 on page 152](#), and setup the equipment as shown in [table 17](#).

Table 17 **Equipment Setup**

Signal Generator settings	
Set...	to...
RF frequency	800 MHz
RF amplitude	0 dBm
all modulation	Off
$\pi/4$ DQPSK I/Q Modulator settings	
Set...	to...
polarity switch	νορμαλ (σωιτχη ουτ)
filter switch	$\infty = 0.35$ (σωιτχη ουτ)
S1 switch on back panel (Bit Clock Control, see figure 55 on page 152)	down position ¹

1. This selects the bit clock for the input's clock frequency.

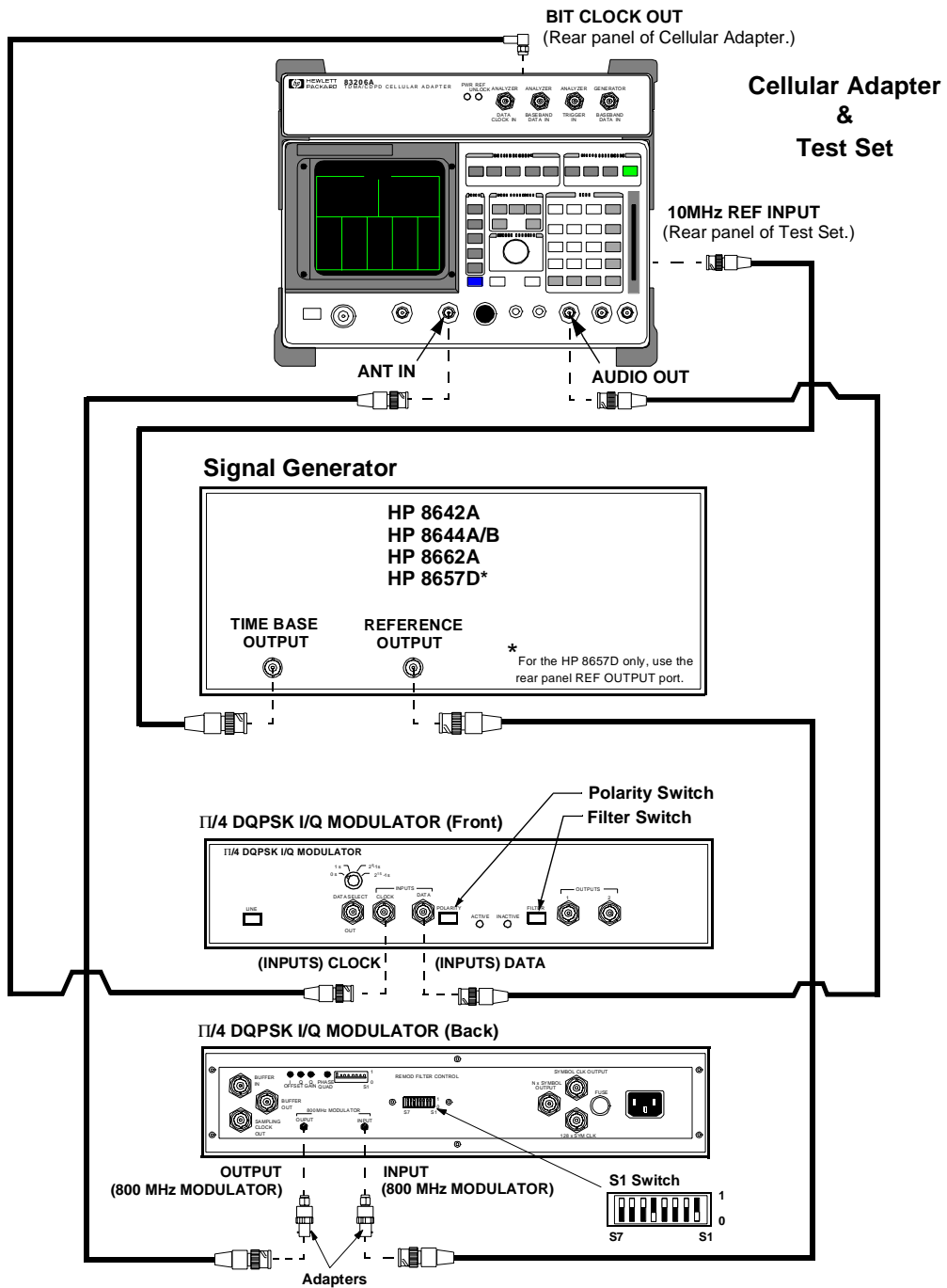

Figure 55 Setup for TDMA Analyzer Accuracy Performance Test 1

Procedure

NOTE: Press the PRESET key on the Test Set before beginning.

Step 1. Setup the RX TEST screen (see figure 56).

- a. Set the AFGEN Freq field to 14 kHz.
- b. Set the AFGen1 To field as follows:
 - destination to Audio Out
 - level to 4 volts

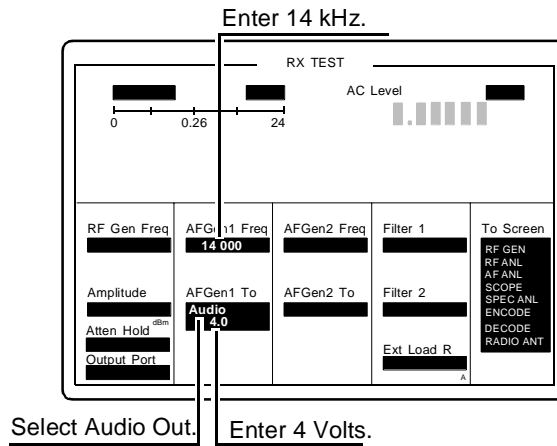

Figure 56 Setting up the RX TEST Screen for the EVM Performance Test

Step 2. Setup the RF ANALYZER screen (see figure 57).

- a. Set the Tune Mode field to Manual.
- b. Set the Tune Freq to 800 MHz.
- c. Set the Input Port field to Ant.

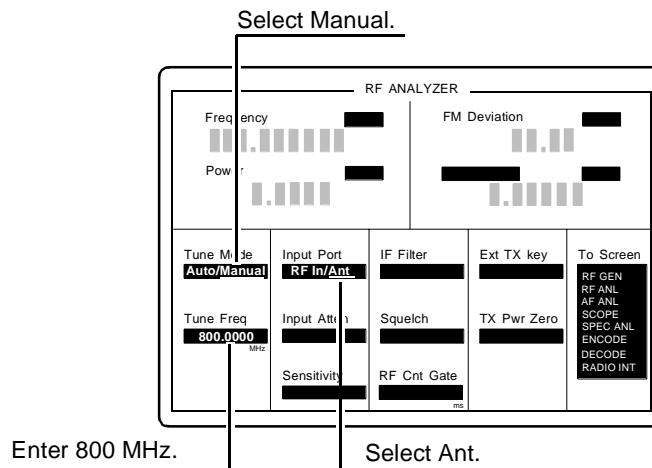

Figure 57 Setting up the RF ANALYZER Screen for the EVM Performance Test

Step 3. Setup the TDMA screen (see figure 58).

- a. Select the More function.
- b. Select the TDMA Test from the Choices menu.
- c. Set the Std Setup field to EVM Base.
- d. Set the Gain field to 12 dB.

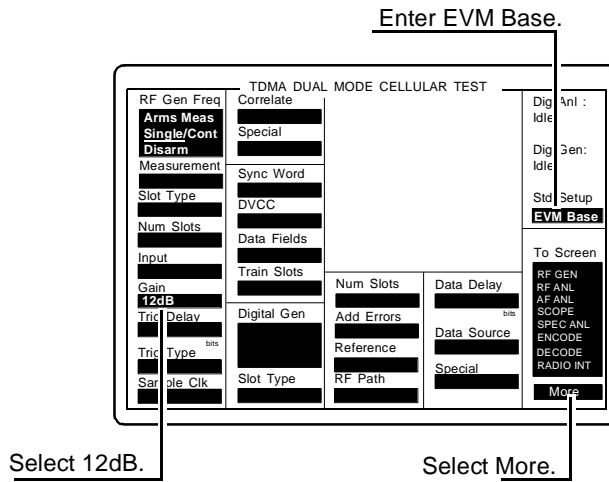

Figure 58

Setting up the TDMA DUAL MODE CELLULAR TEST Screen for EVM performance Test

Step 4. Make the measurement (see figure 59).

- a. Select the Arm Meas field.
- b. Read the measurement Status displayed. The measurement Status should be 0 to indicate a valid measurement. If “0” is not the value, see table 18 for other indicators and solutions.
- c. Read EVM %. This reading should be £2.4%.
- d. Record the analyzer EVM accuracy result on the "TDMA Performance Tests Record" on page 168.

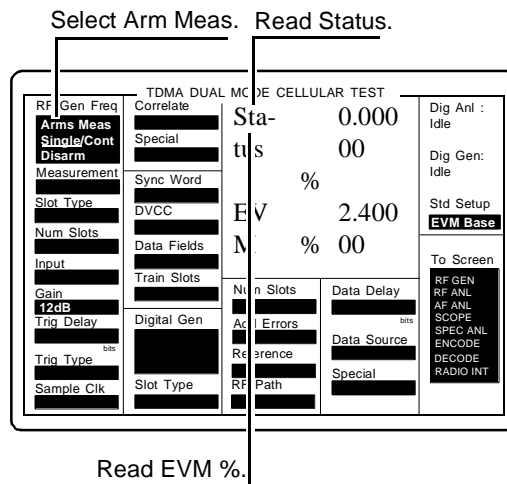

Figure 59 TDMA DUAL MODE CELLULAR TEST Screen

Table 18 Status Indicators and Solutions

If the status displayed is...	This indicates...	Solution
4, 8, or 12	...there is no input signal or the signal is very weak.	<ol style="list-style-type: none"> 1. increase the gain field of the TDMA screen. 2. Check test setup connections and initial test equipment settings. 3. Check the settings used during the test procedure.
16	...the signal on the input is too large and that the analog to digital converter is being overdriven.	Reduce the dB in the Gain field of the TDMA screen.

TDMA Generator Accuracy Performance Test 2

Description

The UUT is set up to perform a self test. The digital generator is set to generate a TDMA signal that simulates a mobile radio. This signal is measured by the analyzer and the accuracy is reported.

Equipment Set Up

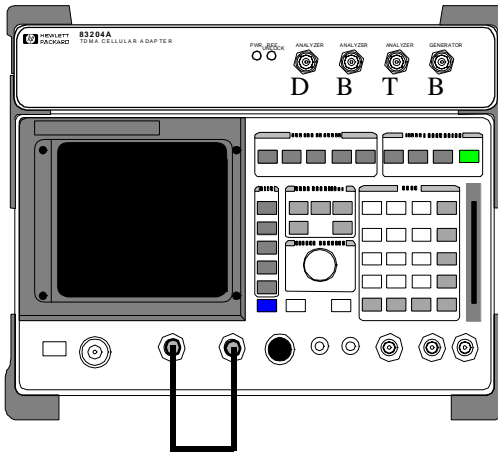

Figure 60

Setup for TDMA Generator Accuracy Performance Test 2

Procedure

Step 1. Setup the RF Analyzer screen (see figure 61).

- a. Set the Tune Mode field to Manual.
- b. Set the Tune Freq to 850 MHz.
- c. Set the Input Port field to Ant.

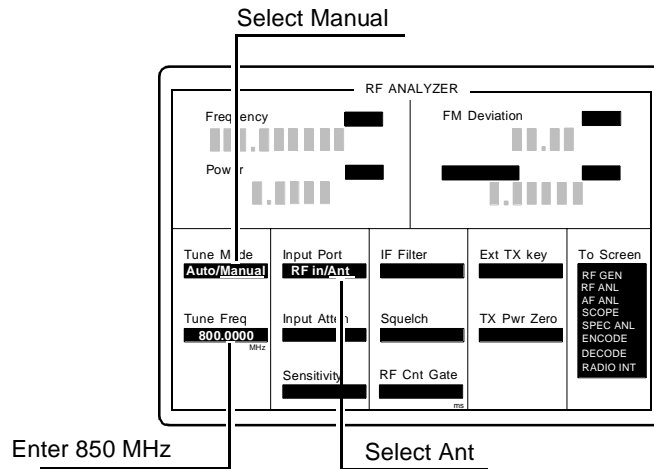

Figure 61

RF ANALYZER Screen for TDMA Performance Test 2

Step 2. Setup the RF GENERATOR screen (see figure 62).

- a. Set the RF Gen Freq field to 850 MHz.
- b. Set the Output to Dupl.
- c. Set the Amplitude field to -40 dBm.
- d. Set the AFGen1 To field to OFF.

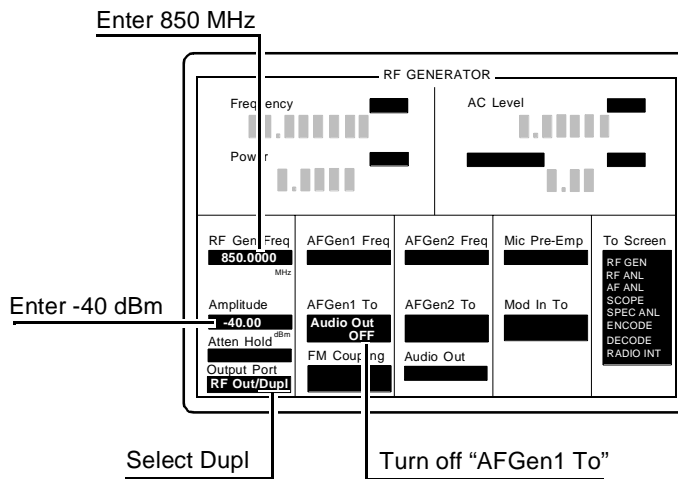

Figure 62

RF GENERATOR Screen for TDMA Performance Test 2

Step 3. Setup the TDMA screen (see figure 63).

- a. Set the Std Setup field to EVM Mobil.
- b. Set the Trig Delay field to 0.
- c. Set both of the Slot Type fields to TDMA Mobil.
- d. Set the Digital Gen field to Send.

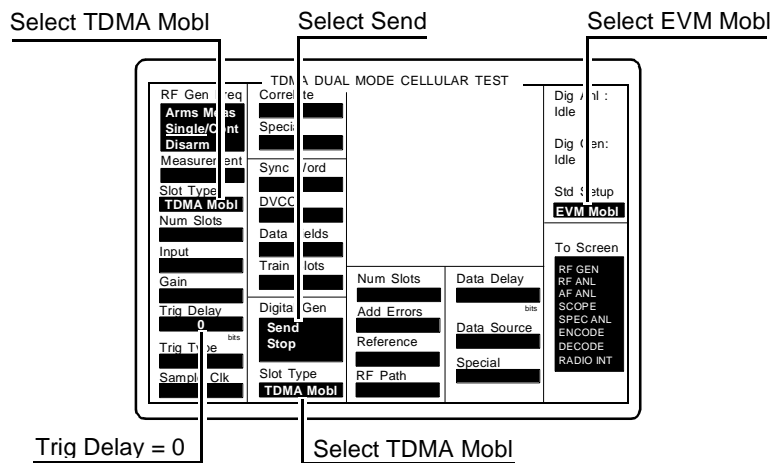

Figure 63

TDMA DUAL MODE CELLULAR TEST Screen for TDMA Performance Test 2

Step 4. Make the measurement (see figure 64).

- a. Select the Arm Meas field.
- b. Read the measurement Status displayed. The measurement Status should be 0 to indicate a valid measurement.
- c. Read EVM %. This reading should be 3.0%.
- d. Record the generator EVM accuracy result on the "TDMA Performance Tests Record" on page 168.

Figure 64

Measuring EVM with the TDMA DUAL MODE CELLULAR TEST Screen

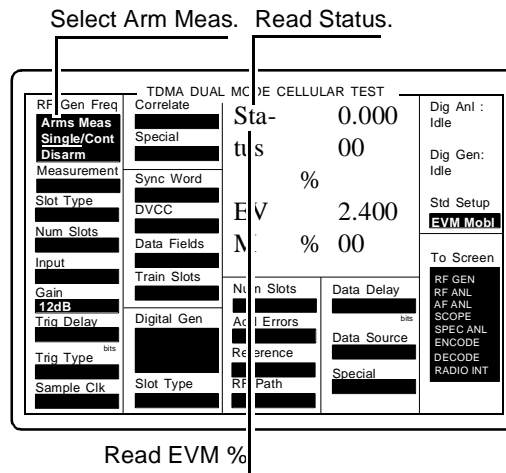

CDPD Performance Test

Description

The following performance procedures applies only to options 002 and 003 of the Cellular Adapter. The spectral purity, modulation accuracy, and on/off level of the CDPD Generator are measured directly with the CDPD analyzer.

Equipment Set Up

No external test equipment is required.

Procedure

Step 1. Load the CDPD MDBS Cell Site Test Software.

- a. Press the PRESET key.
- b. Insert the CDPD MDBS Cell Site Test Software card, HP 83204-61807.
- c. Press the TESTS key.
- d. Select **Card** for procedure location and **CDPD** for procedure filename.
- e. Run the test, press k1 (**Run Test**). Wait (30 seconds to 2 minutes) for the (CDPD) Main Menu to appear, see figure 65.

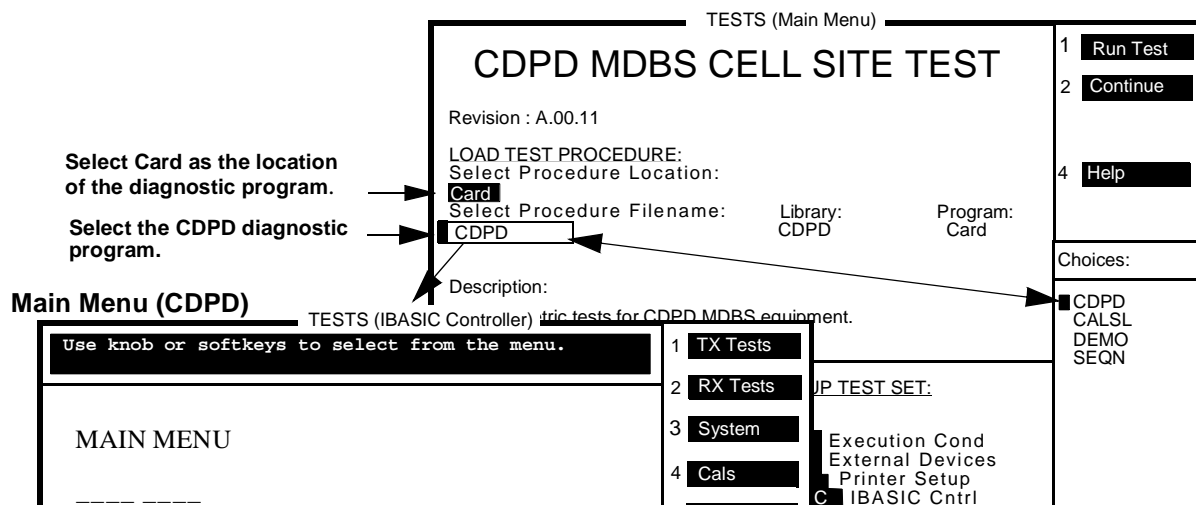

Figure 65 Main Menu (CDPD)

Step 2. Calibrate and record the GMSK Deviation.

- a. From the MAIN MENU, select (4) **Calibrations**. The CALIBRATIONS menu appears, see figure 66.



Figure 66

CALIBRATIONS Menu

- b. From CALIBRATIONS menu, select (3) **GMSK Deviation Calibration**, an equipment cable-hookup screen appears.
- c. Connect Test Set and Cellular Adapter as shown on the screen - connect Test Set's RF IN/OUT to Cellular Adapter's RF IN/OUT TO TEST SET.
- d. Press the k2 (**Continue**). Wait for the **GMSK Deviation Calibration** measured value to appear, [figure 67](#) . WRITE DOWN the measured value for later use.

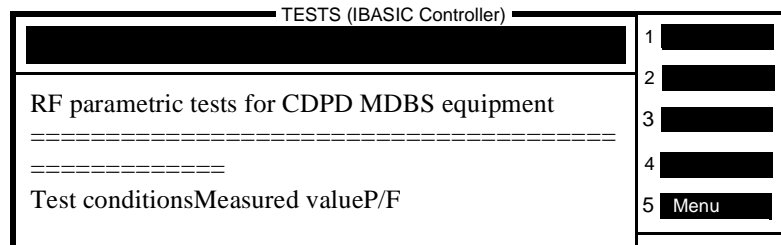

Figure 67

GMSK Deviation

- e. Press k5 (**Menu**) to return to the CALIBRATIONS menu.
- f. From the CALIBRATIONS menu, press k5 (**Prev Menu**) to return to the MAIN MENU screen.

Step 3. Perform Transmitter Tests.

- a. From the MAIN MENU, select (1) **Transmitter Tests**. The TRAMSMITTER TESTS menu appears, see figure 68.

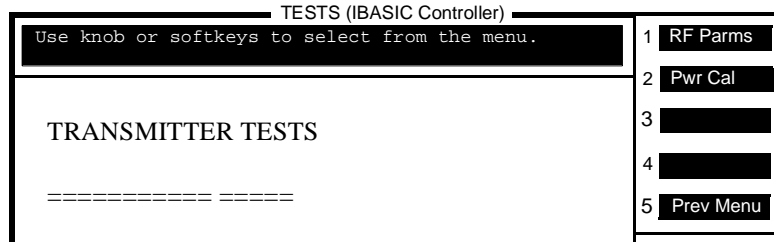

Figure 68 Transmitter Tests Menu

- b. Select (1) **RF Parameters**, or press the k1 key.
- c. Connect the Test Set and Cellular Adapter as shown on the screen. Do not connect the Cellular Adapter to the base station. (Test Set's RF IN/OUT is still connected to Cellular Adapter's RF IN/OUT TO TEST SET.)
- d. Press k2 (**Continue**). The TESTS (IBASIC Controller) screen reports **No signal found**.
- e. Press SHIFT and CANCEL keys.
- f. Connect the DUPLEX OUT to ANT IN on the Test Set.
- g. Move the cursor to the message block and enter `OUTPUT 10;"XMIT_MDBS 2"`, see figure 69. Use the Test Set's cursor control knob to select each character from the choices menu and then select **DONE**.
- h. Change the output statement to `OUTPUT 10;"WR_AMPL_OFF"`. After entering, select **DONE**.

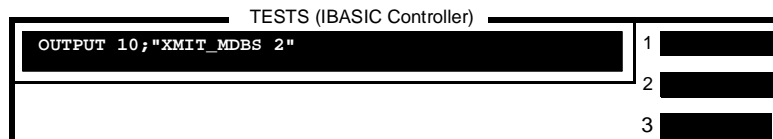

Figure 69

Step 4. Setup the RF GENERATOR screen.

- a. Select **RF GEN** from the **To Screen** menu. The RF GENERATOR screen appears, see figure 70.
- b. Set **RF Gen Freq** to 870 MHz.
- c. Set **Amplitude** to -20 dBm.
- d. Turn **ON** the **Mod In To**, press the ON/OFF key. Verify that the value in this field is the same as the GMSK Deviation Calibration value recorded in step 2d.
- e. Select **DC FM Zero**.

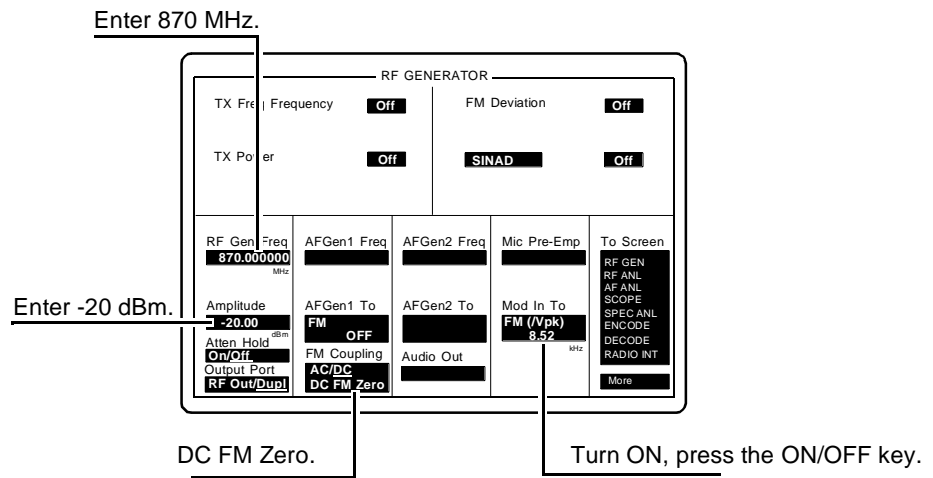

Figure 70

Setting up the RF GENERATOR Screen for the CDPD Performance Test

Step 5. Setup the RF ANALYZER screen.

- a. Select the **RF ANL** from the **To Screen** menu. The RF ANALYZER screen appears, see figure 71.
- b. Set **Tune Mode** to **Manual**.
- c. Set **Tune Freq** to **870 MHz**.
- d. Set **Input Port** to **Ant**.

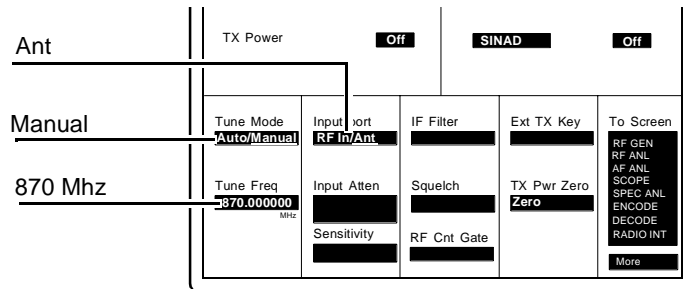

Figure 71 RF ANALYZER Screen

Step 6. Access the CDPD SCREEN.

- a. Select the **More** from the **To Screen** menu.
- b. Select **CDPD TEST**. The CDPD SCREEN appears.
- c. Set **Digital An1** to **Cont**, see figure 72.
- d. Verify **Status** is **3.00000**.

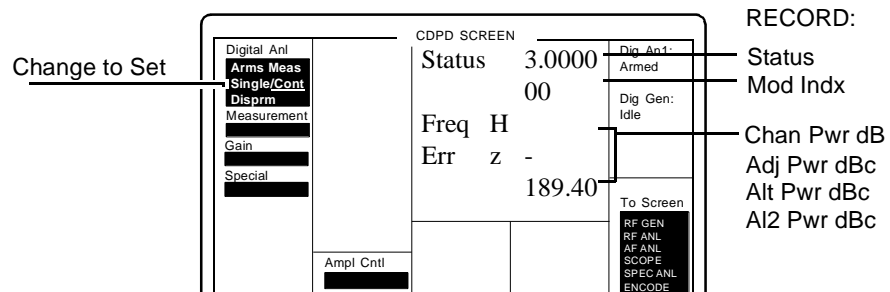

Figure 72 CDPD SCREEN

Step 7. Record CDPD SCREEN information.

- a. Record the adjacent channel power, Adj Pwr dBc, in the "CDPD Performance Test Record" on page 169.
- b. Record the first alternate channel power, Alt Pwr dBc, in the "CDPD Performance Test Record" on page 169.
- c. Record the second alternate channel power, AI2 Pwr dBc, in the "CDPD Performance Test Record" on page 169.
- d. Record the modulation index, Mod Indx, in the "CDPD Performance Test Record" on page 169.

Step 8. Calculate On/Off Power Level

- a. Record the present value for channel power, **Chan Pwr dB**, as ON POWER in the equation below and in the "CDPD Performance Test Record" on page 169.
- b. Change **Ampl Cntrl** to **CDPD**, see figure 73.

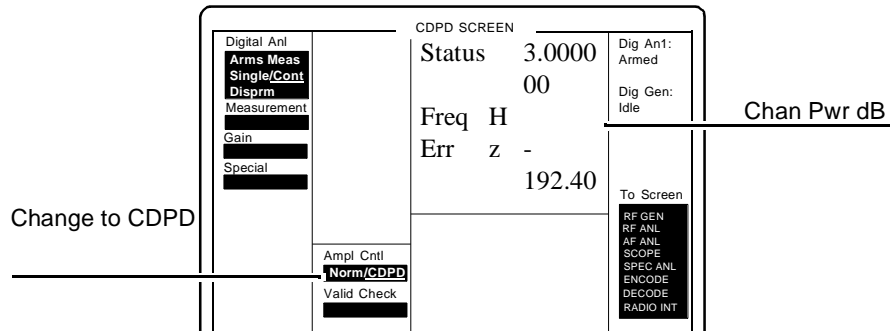

Figure 73

CDPD SCREEN

- c. Record the **Chan Pwr dB** of the CDPD SCREEN as OFF Power in the equation below and in the "CDPD Performance Test Record" on page 169:
- d. Calculate in the equation below the On/Off Differential level and record it in the "CDPD Performance Test Record" on page 169

ON POWER – OFF POWER = ON/OFF DIFFERENTIAL

_____ – _____ = _____

TDMA Performance Tests Record

- HP 83204A TDMA Cellular Adapter (Opt 001)
- HP 83204A TDMA/CDPD Cellular Adapter (Opt 003)

Date _____ Time _____ Humidity _____

Tested by: _____

Cellular Adapter Serial Number: _____

Test Set Serial Number _____

Test Set Last Calibration Date _____

TDMA Performance Test 1 Analyzer EVM Measurement

Frequency (MHz)	Measured EVM Limit (%)	
	Upper	Actual
800	≤ 2.4	

TDMA Performance Test 2 Generator EVM Measurement

Frequency (MHz)	Measured EVM Limit (%)	
	Upper	Actual
800	≤ 3.0%	

CDPD Performance Test Record

- HP 83204A CDPD Cellular Adapter (Opt 002)**
- HP 83204A TDMA/CDPD Cellular Adapter (Opt 003)**

Date _____ Time _____ Humidity _____

Tested by: _____

Cellular Adapter Serial Number: _____

Test Set Serial Number _____

Test Set Last Calibration Date _____

CDPD Generator Spectral Purity Measurement

Channel Power	Upper Limit (dBc)	Measured Spectral Purity Actual (dBc)
Adjacent Channel Power (Adj Pwr dBc)	-26	
First Alternate Channel (Alt Pwr dBc)	-45	
Second Alternate Channel (Alt Pwr dBc)	-60	

CDPD Modulation Accuracy Measurement

Upper Limit	Lower Limit	Modulation Index (Mod Indx)
0.525	0.475	

CDPD Generator On/Off Level Measurement

Measured Values		Calculated Value (dB)	
ON POWER	OFF POWER	ON/OFF DIFFERENTIAL ¹ Actual	Lower Limit
			15

1. ON POWER – OFF POWER = ON/OFF DIFFERENTIAL

Specifications

This chapter contains the TDMA, CDPD, and physical specifications of the HP 83204A TDMA (Opt 001), HP 83204A CDPD (Opt 002), and HP 83204A TDMA/CDPD (Opt 003) Cellular Adapters.

HP 83204A TDMA Specifications

The HP 83204A TDMA Cellular Adapter, Option 001, has no specifications of its own. The TDMA Cellular Adapter can be purchased separately or as part of a system (HP 8921A Option 500) which includes the HP 8921A Cell Site Test Set. The Test Set's specifications account for the performance of the Cellular Adapter. The specifications described below are for the complete Test System.

NOTE:

The following specifications describe the TDMA Test Systems: HP 8921A Option 500, that is HP 8921A Test Set & HP 89204A TDMA Cellular Adapter, or, the HP 892A1 Test Set & HP 89205A TDMA/CDPD Cellular Adapter.

TDMA Signal Generator

Frequency Range: 824 MHz to 894 MHz

Output Level Range:

- RF IN/OUT: -22 dBm to -127 dBm
- DUPLEX OUT: +4 dBm to -127 dBm

Residual Error Vector Magnitude: <3.0%

Residual Phase Error: <3°

Residual Magnitude Error: <3.0%

IQ Origin Offset: <-30 dBc within ±15° C of last calibration

Frequency Error: ±4 Hz plus reference

TDMA Analyzer

Frequency Range: 824 MHz to 894 MHz

Input Level Range:

- RF IN/OUT: 1 mW to 60 W (0 to +47.78 dBm)
- ANT IN: -36 dBm to +17 dBm

Input Frequency Setting Error: 1 kHz

RX DSP Level Setting Range: 0 dB to -23 dB full scale

Residual Error Vector Magnitude: <2.0%

Error Vector Magnitude Measurement Accuracy: 0.4% +2% of reading

Residual Phase Error: <1.5°

Residual Magnitude Error: <1.4%

IQ Origin Offset Accuracy: ±0.5 dB for values to -40dBc

Frequency Error Accuracy: ±2 Hz plus reference

HP 83204A CDPD Specifications

The following specifications apply to the HP 83204A CDPD (Opt 002) and HP 83204A CDPD/TDMA (Opt 003) Cellular Adapter when fitted with the HP 8921A Cell Site Test Set, and when running the provided CDPD MDDBS Cell Site test software (this software is included with each of these Cellular Adapters).

CDPD Signal Generator

The following specifications apply to the signal at the DUPLEX OUT port of the HP 8921A Cell Site Test Set.

Output:

- Level and Range Accuracy: Same as HP 8921A Test Set
- Reverse Power: Same as HP 8921A Test Set
- Frequency Range: Same as HP 8921A Test Set
- Frequency Accuracy: ± 500 Hz, typically ± 50 Hz

Spectral Purity:

- Spurious Signals, Adjacent Channels: < -26 dBc
- Spurious Signals, First Alternate Channel: < -45 dBc
- Spurious Signals, Second Alternate Channel: < -60 dBc

Switching Speed: *Typically < 150 ms to be within 1 kHz*

Transmitter On/Off Level and Timing: > 15 dB down in < 1 ms

Modulation Type: GMSK with BT = 0.5

Modulation Accuracy: $< 5\%$ error in modulation index

CDPD Analyzer

RF Frequency Range: Same as HP 8921A Test Set

Input Level Range: Same as HP 8921A Test Set

RF Power Measurement:

Accuracy: RF IN/OUT: 5%, ± 0.01 mW (at $25^\circ \pm 10^\circ$ C) for single signal > 200 mW, 10% over full temperature range.

Frequency Error Accuracy: Time base accuracy ± 1 Hz

Modulation Index Accuracy: < 0.1% error in modulation index

Adjacent Channel Power measurement floor: Typically -45 dBc

Alternate and Second Alternate Channel Power measurement noise floor:
Typically -60 dBc

Physical Specifications

Power requirements: 100 to 240 V; 50 to 60 Hz; 100 VA.

Operating temperature range: 0° to 55° C.

Leakage: Conducted and radiated interference meets CISPR 11 and FTZ 1046.

Weight:

- HP 83204A TDMA Cellular Adapter (Opt 001): 4.5 kg (10 lbs) net, 6.8 kg (15 lbs) shipping.
- HP 83204A CDPD Cellular Adapter (Opt 002): 4.5 kg (10 lbs) net, 6.8 kg (15 lbs) shipping.
- HP 83204A TDMA/CDPD Cellular Adapter (Opt 003): 4.5 kg (10 lbs) net, 6.8 kg (15 lbs) shipping.

Dimensions: 62 H × 330 W × 456 D mm (2.4 H × 13 W × 18 D in).

A

- A10 Directional Coupler & Switch assembly, 122
 - block diagram, 114
 - description, 122
- A10 Directional Coupler & Switch assembly
 - removal, 91
- A11 CDPD assembly, 122
- A11 CDPD assembly
 - block diagram, 114
 - description, 122
 - removal, 93
 - replacement parts, 139
- A2 RX DSP
 - removal, 94
- A2 RX DSP assembly, 115
 - block diagram, 114
 - description, 115
 - diagnostics, 61, 65
 - replacement parts, 140
- A3 Motherboard assembly, 115
 - description, 115
 - removal, 97
 - replacement parts, 142
- A4 Premod Filter assembly, 115
 - block diagram, 114
 - description, 115
 - diagnostics, 61
 - removal, 97
 - replacement parts, 135
- A5 TX DSP assembly, 117
 - block diagram, 114
 - description, 115
 - removal, 97
 - replacement parts, 142
- A6 Reference/Receiver, 117
 - block diagram, 114
 - diagnostics, 61, 65
 - removal (part of A9), See A9
 - replacement parts (part of A9), See A9
- A6 Reference/Receiver assembly
 - description, 115
- A7 IQ Modulator assembly, 117
 - block diagram, 114
 - description, 115
 - diagnostics, 65
 - removal (part of A9), See A9

- replacement parts (part of A9), See A9
- A8 Power Supply assembly, 117
 - block diagram, 114
 - description, 115
 - removal, 97
 - replacement parts, 142
- A9 Ref/IQ Modulator assembly, 117
 - block diagram, 114
 - description, 102, 117
 - removal, 86–88
 - replacement parts, 137
- Advanced Mobile Phone System, See-
 - AMPS
- AMPS, 107
 - assemblies, list of, 37

C

- Cables, 71
 - CDPD loopback test, 67
 - connection to Test Set, 53
 - DMC_DIAGL setup, 54
 - replacement parts, 129–140
- Calibration, 163
 - CDPD cable loss, 163
 - CDPD center frequency, 163
 - CDPD GMSK deviation, 163
 - CDPD power measurement, 163
 - interval, 42
 - periodic, 149
 - periodics, 42
- CDPD, 174
 - analyzer specifications, 174
 - defined, 107
 - diagnostics, 64
 - error messages, 65
 - generator specifications, 174
 - performance test, 162–167
 - performance test record, 169
 - signal analysis, 111
 - signal generation, 111
 - test system block diagram, 111
 - test system overview, 111
- CDPD assembly (A2), 114
 - block diagram, 114, 122
 - description, 122
 - removal, 93
- CDPD/TDMA performance tests, 148
- CDPD_DIAG, 65
- Cellular Adapter, 36
 - CDPD, 40
 - options, 36
 - TDMA, 39
- Codes, 52
 - error, 52
 - failure, See error codes

D

Diagnostics, [62](#)
 CDPD_DIAG, [62](#)
 digital loopback, [64–67](#)
 RF loopback, [64–67](#)
 self test, [64–67](#)
Dimensions, [176](#)
Direction Coupler Assembly (A10), [114](#)
 block diagram, [114](#)
 description, [113](#)
 removal, [91](#)
 replacement parts, [138](#)
Disassembly, [73](#)
 removing A10 Directional Coupler, [91](#)
 removing A11 CDPD assembly, [93](#)
 removing A2 RCV DSP assembly, [94](#)
 removing A3 Motherboard assembly,
 [97](#)
 removing A4 Pre-mod Filter assembly,
 [84](#)
 removing A5 TX DSP assembly, [94](#)
 removing A8 Power Supply assembly,
 [78](#)
 removing A9 Ref/IQ Mod assembly, [86](#)
 removing cover, [75](#)
 removing front panel, [80](#)
 removing rear panel, [82](#)
 seperating HP 83204 and HP 8921, [75](#)
DMC_DIAGL, [54, 58](#)
 all tests, [57](#)
 EVM loopback, [57](#)
 Ref/RX & Pre-Mod Filt (A4/A6), [57](#)
 RX DSP (A2), [57](#)
DMC_DIAGN, [62](#)
 IQ Modulator (A7), [65](#)
 Premod/Filter/IQ Drive (A6), [65](#)
 RX Downconverter (A4)/Rcv DSP
 (A2), [65](#)
Documentation, [44](#)
 HP 83204 Software User's Guide, [44](#)
 HP 83204 User's Guide, [44](#)
 HP 8920,8921 repair manual, [44](#)
Dual mode, [108](#)

E

E-mail address, Spokane service, [44](#)
Error codes, [56](#)
 LED patterns, [56](#)
 Power up self test failure, [52](#)
Error messages, CDPD, [66](#)
Error-vector magnitude, *See* EVM loop-
 back
EVM loopback test, [61](#)

F

Factory support, [44](#)
Failure codes, *See* error codes, [44](#)
Firmware, [101](#)
 loading, [101](#)
 upgrades, [100](#)
 verification, [105](#)
Fuse, [134](#)

H

HP 83204A, [36](#)
description, [36](#)
options, [37](#)
HP 8921A, [36](#)
description, [36](#)

I

Internet address, Spokane service, [44](#)
Interpreting results, [64](#)
IQ modulator (A7), [62](#)
block diagram, [114](#)
description, [118](#)
diagnostics, [62](#)
removal, [97](#)
Item, [143](#)

L

LEDs, [55–56](#)
LEDs, power up, [55](#)
error patterns, [55](#)
location of, [56](#)

M

Manuals, [44](#)
 HP 83204 Software User's Guide, [44](#)
 HP 83204 User's Guide, [44](#)
 HP 8920,8921 repair manual, [44](#)
MDBS, [108](#)
Mobile Data Base Station, *See* MDBS

O

Operating manuals, [44](#)
 HP 83204 Software User's Guide, [44](#)
 HP 83204 User's Guide, [44](#)
Options, [36](#)
 Option 001 TDMA, [36](#), [37](#)
 Option 002 CDPD, [36](#), [37](#), [129](#), [138](#)
 Option 003 TDMA/CDPD, [36](#), [37](#)

P

Parts, [44](#)
 ordering, [44](#)
 replacement, [128-??](#)
PER_CALD, [149](#)
Performance tests, [151](#)
 CDPD, [162](#)
 Test 1, TDMA analyzer accuracy, [151](#)
 Test 2, TDMA generator accuracy, [157](#)
Periodic calibration, [149](#)
Phone numbers
 customer support, [11](#)
Phone numbers, factory support, [44](#)
Power distribution block diagram, [125](#)
Power requirements, [176](#)
Power Supply assembly (A8), [117](#)
 description, [117](#)
 removal, [78](#)
Power up, [56](#)
Power up, [52](#)
Power-up diagnostics, [52](#)
 Cellular Adapter, [52](#)
 failures, [52](#)
 Test Set, [52](#)
Premodulation Filter assembly, [114](#)
 block diagram, [114](#)
 description, [115](#)
 diagnostics, [57](#), [62](#)
 removal, [97](#)

R

Receiver DSP assembly (A2), 115
 block diagram, 114
 description, 115
 diagnostics, 58, 62
 removal, 94

Reference/IQ Modulator assembly (A9)
 block diagram, 114
 description, 118
 removal, 86–88
 replacement parts, 137

Reference/Receiver (A6), 114
 block diagram, 114
 description, 118
 diagnostics, 58, 62
 removal (part of A9), *See* A9

Repair process, 41

Replaceable, 143

Replaceable assemblies, 41, 89, ??–133

Replaceable parts, 128–133

RX down converter, *See* A4

RX DSP, *See* A2 or Receiver DSP assembly

S

Specifications, 171
 CDPD analyzer, 174
 CDPD signal generator, 174
 physical, 176
 TDMA analyzer, 172
 TDMA cellular adapter, 174

Service, 41
 equipment and tools, 41
 information for Test Set, 45
 support from factory, 45

Support Contacts
 electronic mail, 11
 HP Desk, 11
 telephone, 11

T

TDMA, 172
 analyzer specifications, 172
 diagnostics, 50, 54
 performance test record, 168
 performance tests, 150–161
 signal analysis, 110
 signal generation, 110
 signal generator specifications, 172
 specifications, 172
 test system block diagram, 109
 test system overview, 109

Temperature, operating, 176

Test equipment, 45
 for servicing, 45
 for TDMA tests, 150

Test record, 169
 CDPD, 169
 TDMA, 168

Test results, 60, 64, 67

Test system, 114
 block diagram, 114
 description, 36
 error codes, 52

Time Division Multiple Access, *See*
 TDMA tools, 42

Transmitter DSP assembly (A5), 114
 block diagram, 114
 description, 117
 replacement parts, 141

Troubleshooting, 41, 48
 flow chart, 49
 test system, 48

Troubleshooting *See Also* diagnostics

TX DSP, *See* A5 or Transmitter DSP assembly

U

Upgrades, firmware, [100](#)
User's guide, [44](#)

W

Website, Spokane service support, [45](#)
Weight, [176](#)
Wires, *See* cables